

Glass-Glass Photovoltaic Modules – Overview of Issues

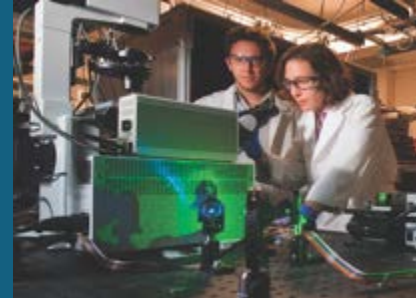

This work was authored in part by the National Renewable Energy Laboratory, operated by Alliance for Sustainable Energy, LLC, for the U.S. Department of Energy (DOE) under Contract No. DE-AC36-08G028308. Funding provided by 30295. The views expressed in the article do not necessarily represent the views of the DOE or the U.S. Government. The U.S. Government retains and the publisher, by accepting the article for publication, acknowledges that the U.S. Government retains a nonexclusive, paid-up, irrevocable, worldwide license to publish or reproduce the published form of this work, or allow others to do so, for U.S. Government purposes.

2018 Fall DuraMAT Workshop
SLAC, CA

PRESENTED BY

Joshua S. Stein & Dirk C. Jordan



Sandia National Laboratories is a multimission laboratory managed and operated by National Technology & Engineering Solutions of Sandia, LLC, a wholly owned subsidiary of Honeywell International Inc., for the U.S. Department of Energy's National Nuclear Security Administration under contract DE-NA0003525.

SAND2018-9698 PE

Market Trends for Glass-Glass or Double Glass PV Modules



- ITRPV 2018 report shows:
 - Glass-glass modules are increasing in market share
 - Frameless modules are increasing
 - Non-EVA encapsulants are increasing.
- Note: ITRPV has routinely underestimated

Different back cover technologies with glass front cover

World market share [%]

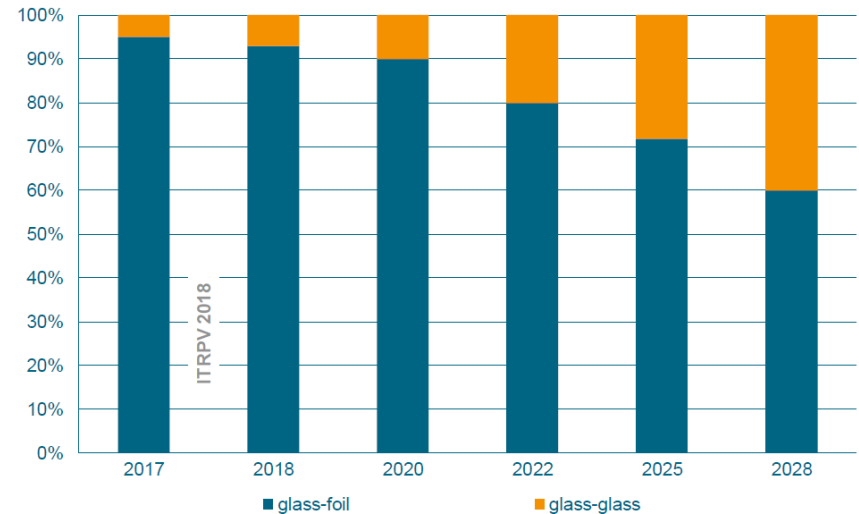

Different encapsulation material

World market share [%]

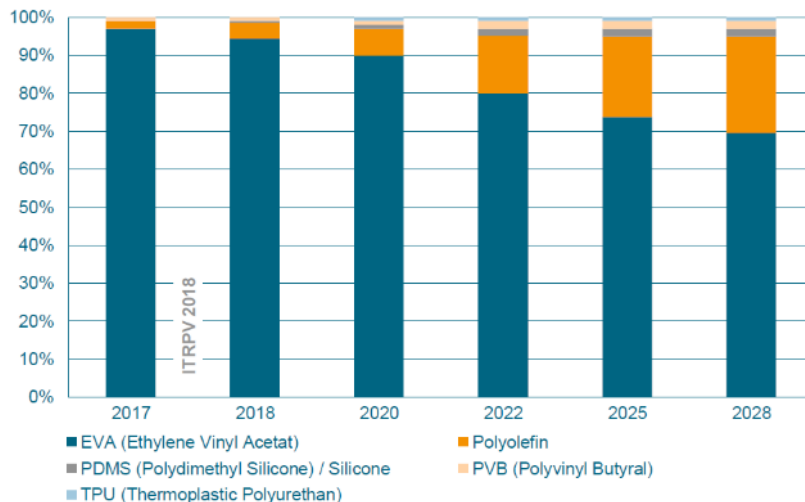

Different frame materials

World market share [%]

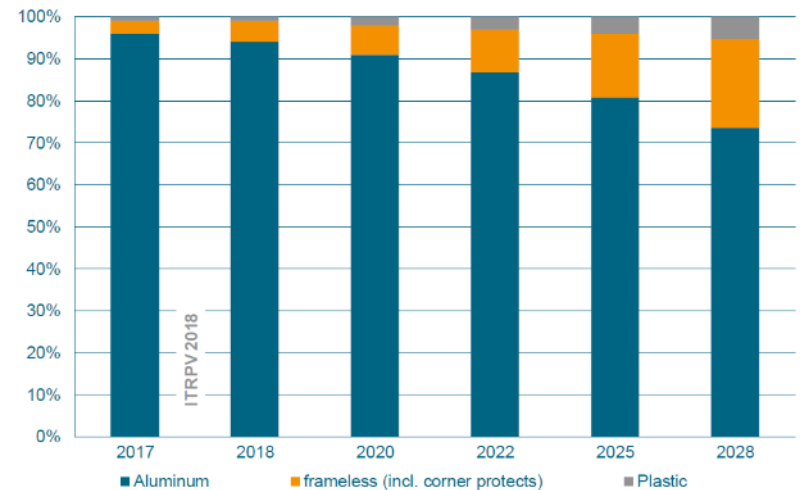

3 Bifacial PV is Expected to Grow



Bifacial cell technology

World market share [%]

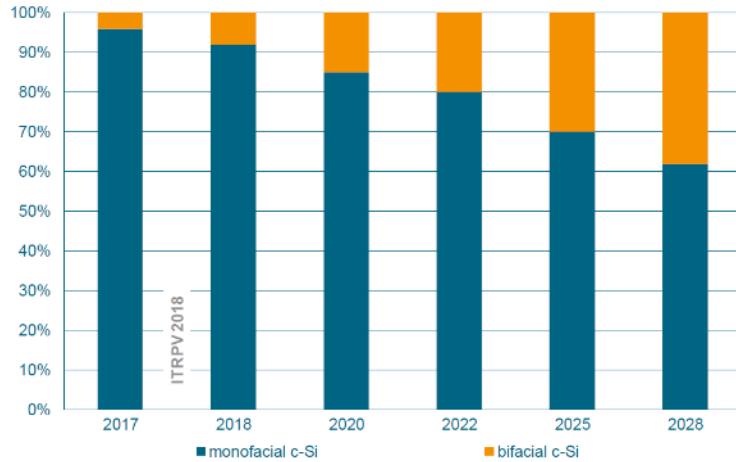

"true" bifacial c-Si modules with bifacial cells and transparent backcover

World market share [%]

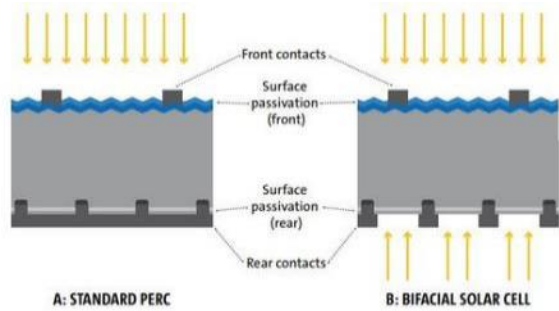
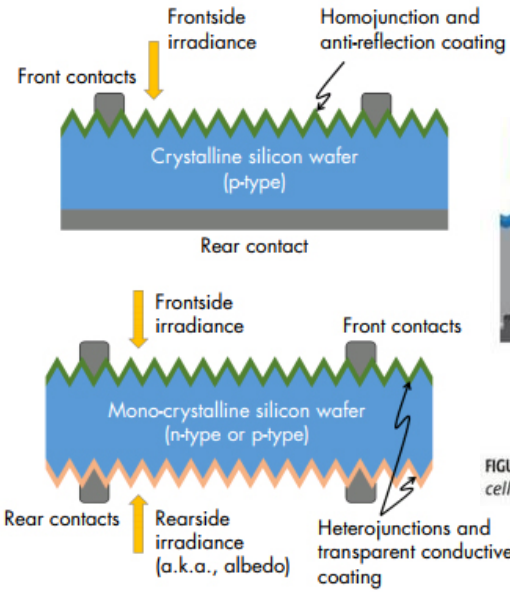
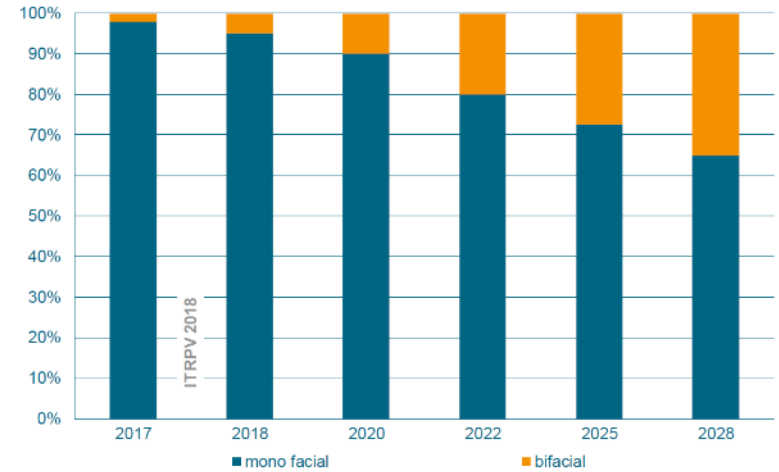

FIGURE 1: Schematic cross-section of PERC structure (A) and a bifacial solar cell (B)





For Example...

- 2014 ITRPV predicted
 - 70% of modules would be 60-cell in 2018
 - 30% would be split between 72-cell,80-cell, and other sizes in 2018
- 2017 ITRPV predicted
 - ~60% of modules would be 60-cell in 2018
 - ~40% would be 72-cell modules
- It is very hard to predict technology pathways....

5th Edition (2014)

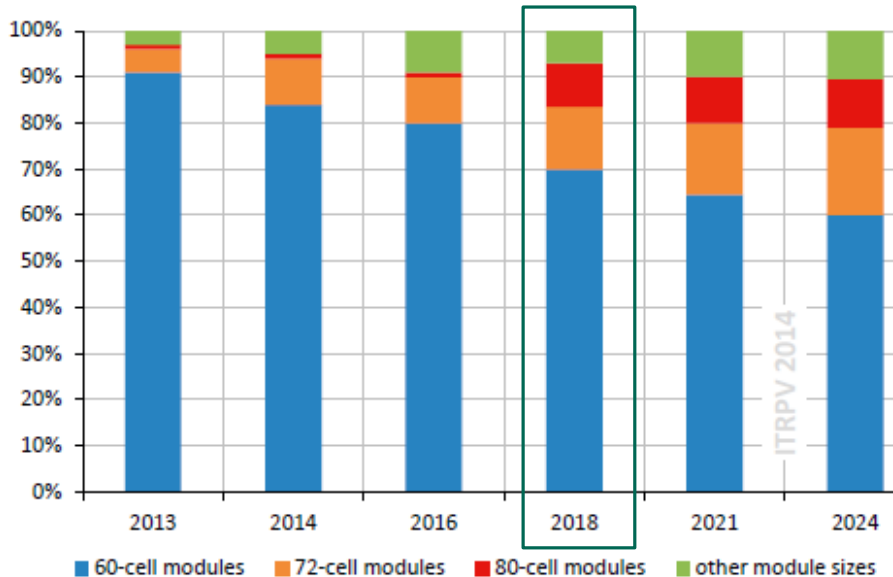

Different module sizes (156x156mm² cell size)
World market share [%]

9th Edition (2017)

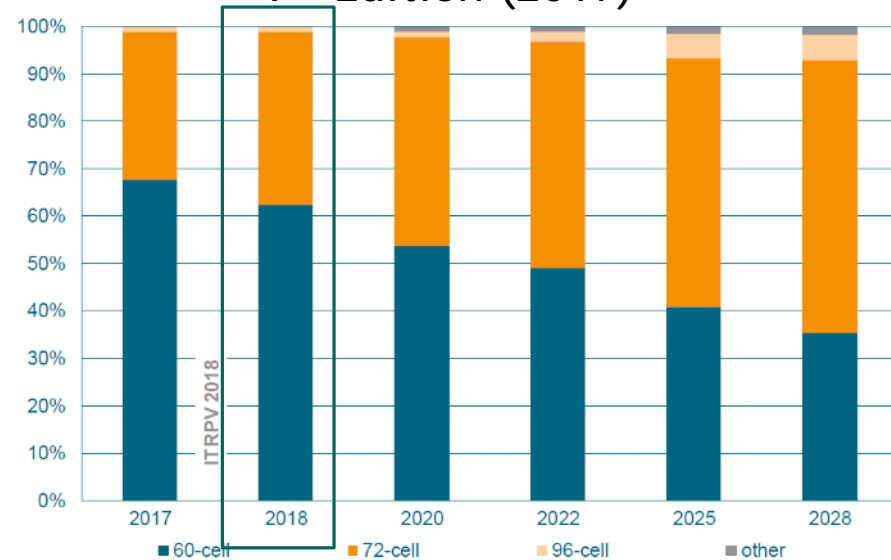

Acknowledgements & Disclaimer



In the following slides we include information gathered from literature, marketing info, spec sheets, and detailed surveys were sent out to selected experts in the field.

We would like to acknowledge the following people:

Bruce King, Danny Cunningham, Carl Osterwald, Mike Deceglie, Peter Hacke, Bill Sekulic, Steve Rummel, Cassidy Sainsbury, Harrison Wilterdink, Stefaan de Wolf, David Young, Xingshu Sun, Muhammad Alam, Sarah Kurtz, Greg Kimball, and Adam Shinn, Ingrid Repins.

Also many who wish to remain anonymous.

Why are Glass-Glass Modules Appealing?



- Double glass construction is stronger and more durable
 - Less prone to back side scratches
 - Less prone to hot spot burns
 - Modules less flammable.
 - Cells are at center of sandwich that reduces stress.
- Allows for frameless designs
 - Preferred for architectural applications
 - No frame = ungrounded systems = reduced risk of PID
- Much lower moisture ingress into module.
- Many companies are offering 30 year warranties on glass-glass modules.

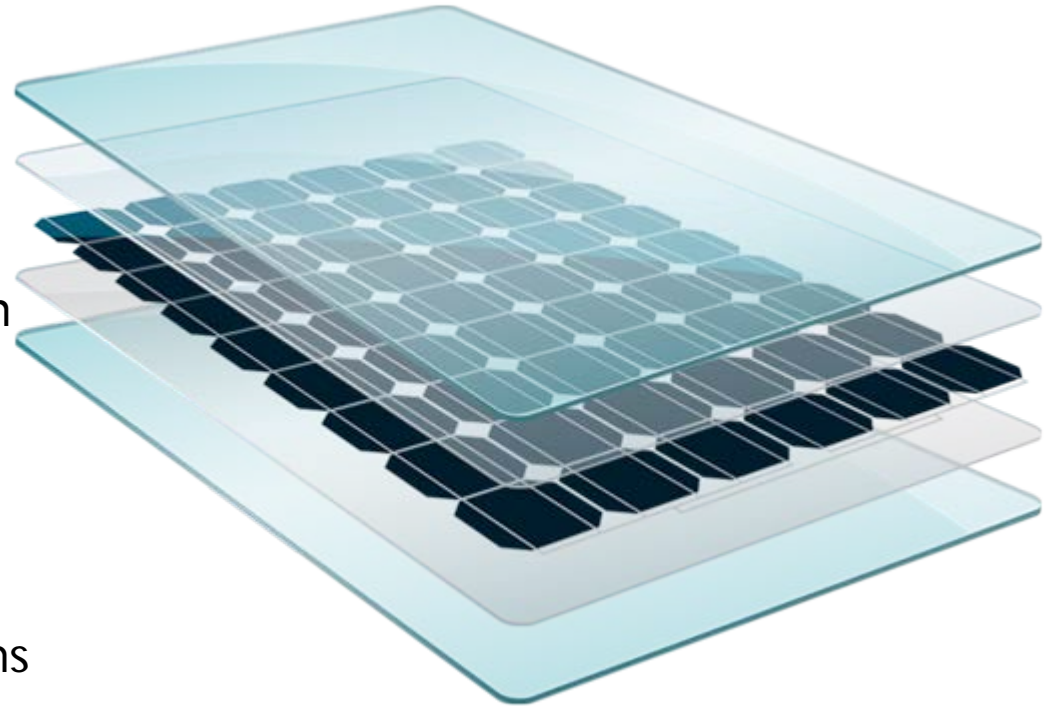



- Higher cost (this is debatable):
 - Increased EVA thickness to reduce risk of microcracks
 - Frameless module clamps more expensive
 - Installation is more difficult and prone to installation errors
 - (e.g. over-torqueing)
- Weight
 - Currently, glass-glass modules (~15.2 kg/m²) are about 35-40% heavier per unit area than glass-backsheet modules (~11.3 kg/m²)*
 - Almaden advertises 2mm double glass modules weighing <12 kg/m²
 - Installation - OSHA limits: 50lbs (22.7kg) for single person lifting
 - 60 cell glass-glass modules are near limit
 - 72 cell glass-glass modules are over the limit (3mm glass)
 - Shipping more expensive

* Based on analysis of a small sample of current module spec sheets



- Use of clear back glass typically results in a “1 power class” penalty (2-5% lower power rating).
 - Recent improvements in quality of structured, thin front glass and addition of either colored EVA or ceramic coatings on glass has largely eliminated this penalty (at a cost).
- Frameless modules collect less soil on module surface
- Frameless modules shed snow quicker than framed modules.
- Higher operating temperatures (more on this later...)

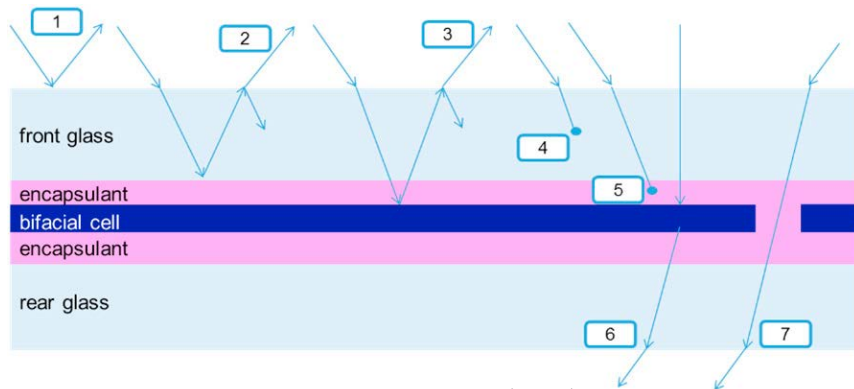



- Conversion of Glass-backsheet line to Glass-Glass Line requires adding:
 - Glass washer
 - Glass Handling robots
 - Additional conveyor or handling equipment
- Frameless modules require significantly different (and more expensive) packaging for transport.
- Cost difference of glass vs. backsheet material is not resolved.
 - Tier 1 manufacturer in China: "glass is cheaper"
 - Tier 1 manufacturer in US: "no significant difference"
 - Others: "glass is more expensive than backsheet"
- Yield loss for glass-glass lines because rework is difficult or impossible.
- Shipping containers need special design due to weight.



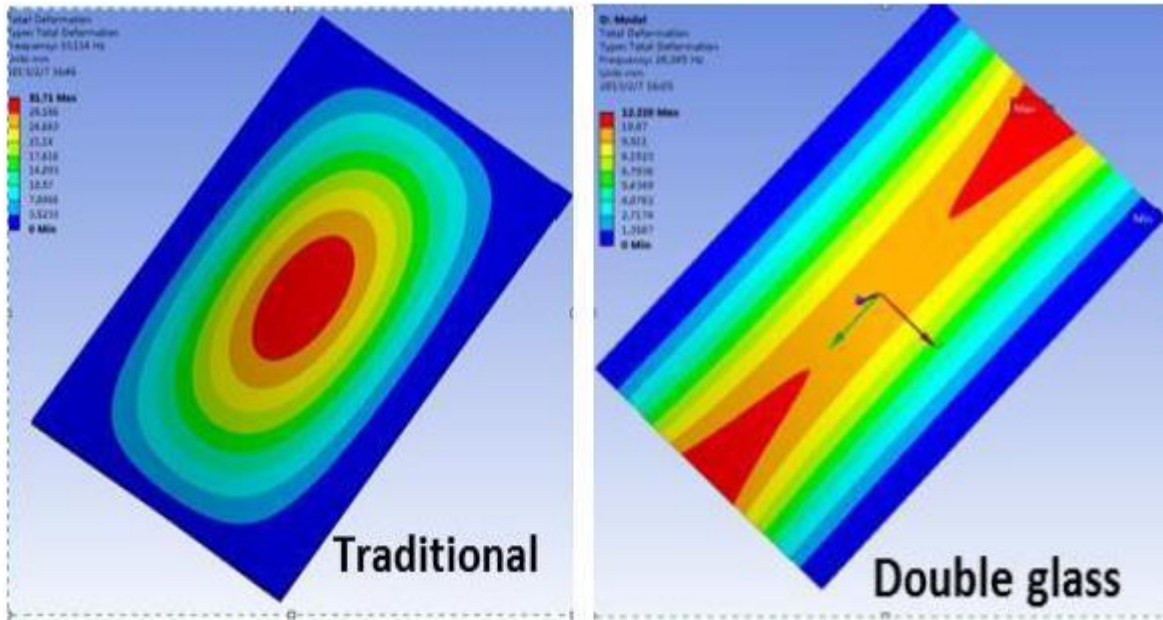

- Deformation of frameless glass-glass module is more uniform than framed glass-backsheet module.
- Mounting clips for glass-glass are typically more complicated and expensive.
- Packing and shipping of frameless glass-glass modules may require additional packing materials and more weight.





Arcotech Solar has developed a new mounting concept where module manufacturers attach narrow metal sleeves to the module's edge. A small mounting clip attaches to this sleeve.

Works especially well for bifacial modules.

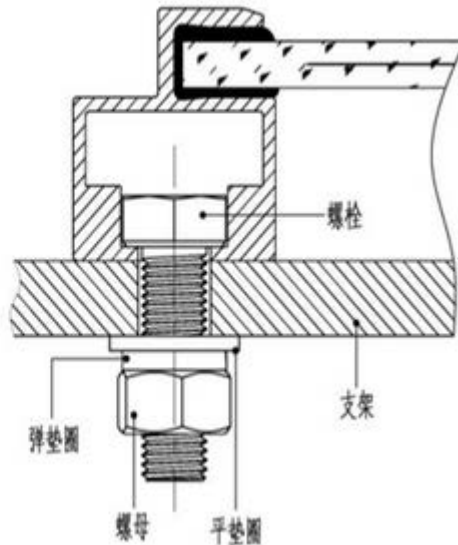
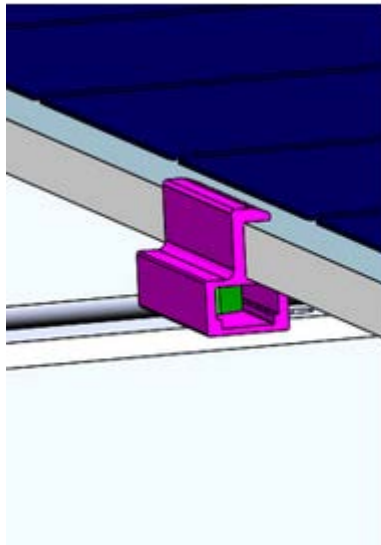

Glass-Glass Potential Module Reliability Issues



- Glass-Glass modules are more durable
 - However with the use of tempered glass on front and back module may be more susceptible to damage from transit or flying rocks during O&M.
 - Damaged backsheet is repairable. Not so with damaged back glass.
- New Failure Modes
 - Bus wires exit through holes cut in back glass. Moisture ingress through these holes may be a problem.
 - Are edge seals necessary?
 - PID issues for bifacial mono PERC modules (possibly cause is due to doubling of the Na⁺ source?)
 - Encapsulants for glass-glass modules (not EVA) have a shorter history.
 - EVA has the risk of outgassing in a glass-glass module
 - Acetic acid buildup inside module can lead to corrosion
- Thermoplastic (polyolefin) does not outgas (Higher softening point, Lower glass transition)
- Glass-Glass modules have lower water vapor transmission rates than glass-backsheet modules.
- Less sand abrasion, more resistant to alkali, acid, or salt mist.



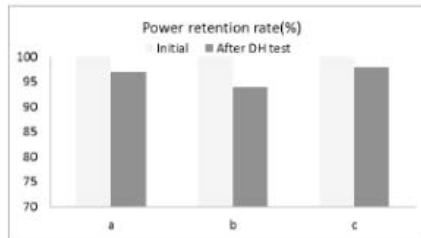
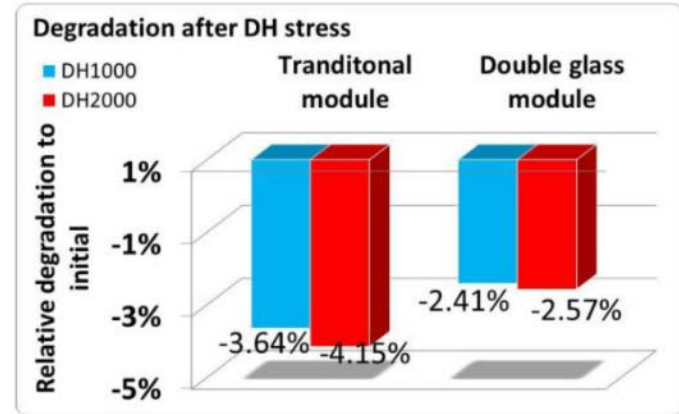

Fig. 1. Power loss under the condition of DH3000h. (a) double glass module before and after DH3000h; (b) conventional module before and after DH3000h; (c) double glass module before and after DH2000h + distortion.



Fig. 2. EL image of double glass module after DH test. (a) DH1000h; (b) DH2000h; (c) DH3000h.

Tang et al., SNEC, 2017.



Zhang et al., 28th EUPVSEC, 2013

Glass-glass have done well in damp heat testing

Because it takes a long time for water to diffuse from the edges good performance in damp heat is expected.



Thermal cycling

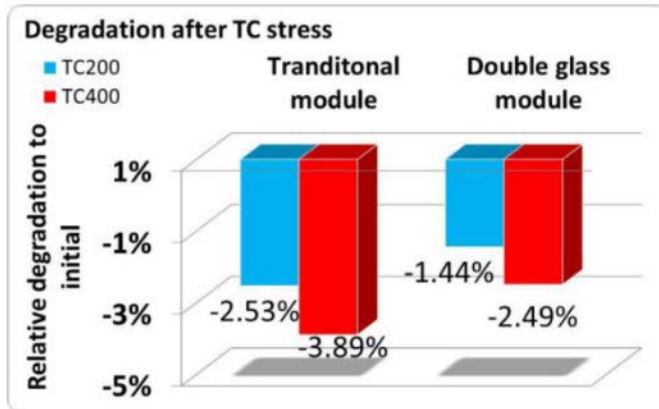

Humidity freeze

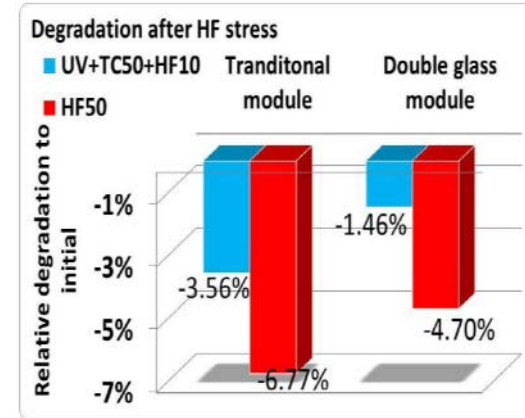

PID

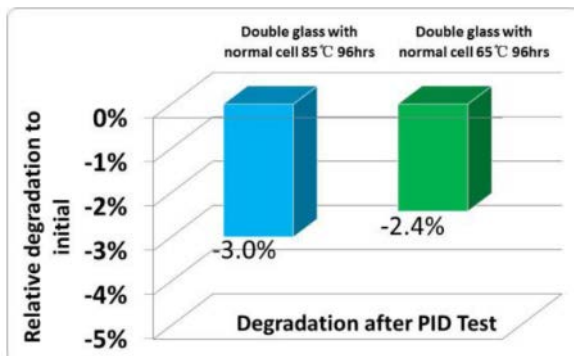

Mechanical load

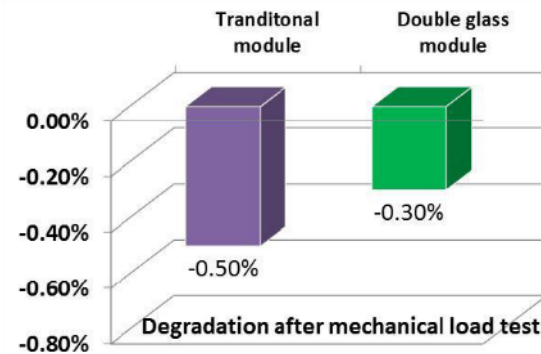

Glass-glass performed well in IEC tests



Test-to-failure

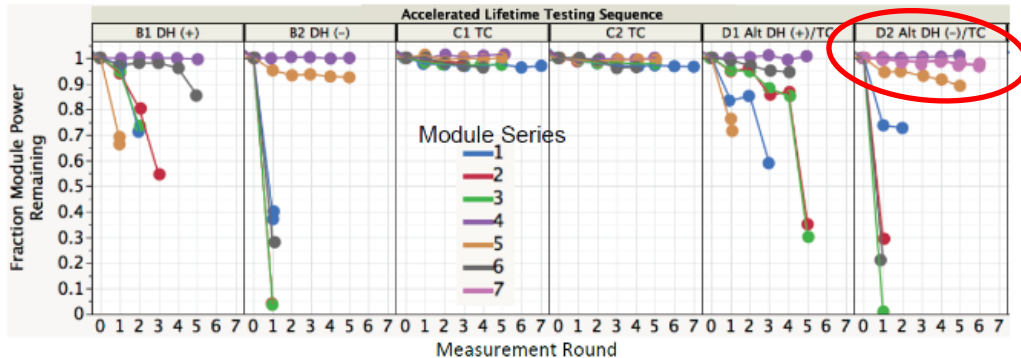

SEQUENCE OF STRESS TESTS

Sequence	A. Control		B. Damp Heat with Bias 85°C/85%RH		C. Thermal Cycling with load -40°C/85°C		D. Alternating Seq. B/C DH/TC		
			5 kW hrs/m ² light soak						
Round 1			DH+	DH-	TC	TC	DH+	DH-	
Round 2			DH+	DH-	TC	TC	TC	TC	
Round 3			DH+	DH-	TC	TC	DH+	DH-	
Round 4			DH+	DH-	TC	TC	TC	TC	
Round 5			DH+	DH-	TC	TC	DH+	DH-	

- DH refers to 1000 hrs 85°C 85% relative humidity, IEC 61215 Ed. 2 sec. 10.13
- DH+(-) indicates +(-) voltage bias of 600 V or module's rated system voltage (whichever is greater on shorted module leads with respect to grounded frame)
- TC refers to 200 cycles between -40°C and 85°C, IEC 61215 Sec. 10.11 (I_{mp} applied when T > 25°C)
- Alt. DH/TC refers to a sequence of alternating 1000 Hrs. DH and TC 200 stress cycles described above

Modules 4 & 7 are glass-glass

Sequential testing

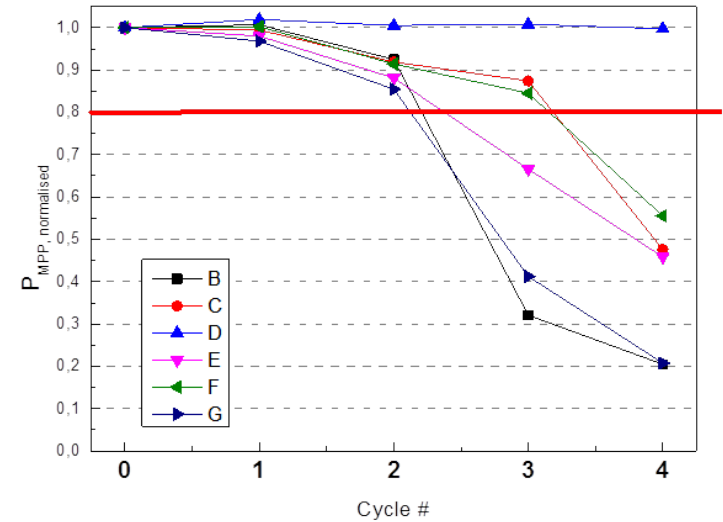

Module D is glass-glass

Side-by-side Comparison of Fielded Modules



P_{max} losses of modules series grouped by back sheet

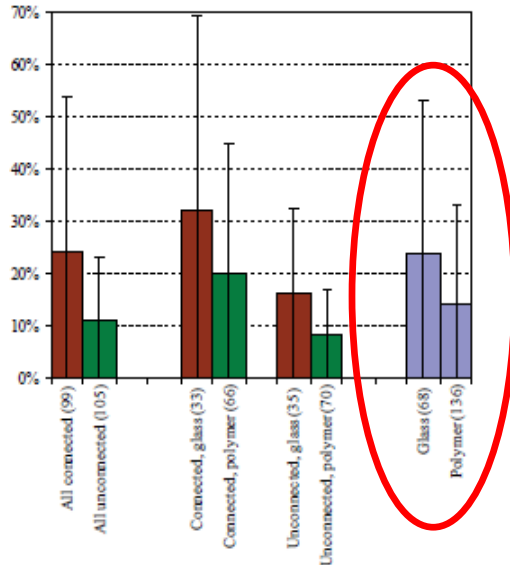
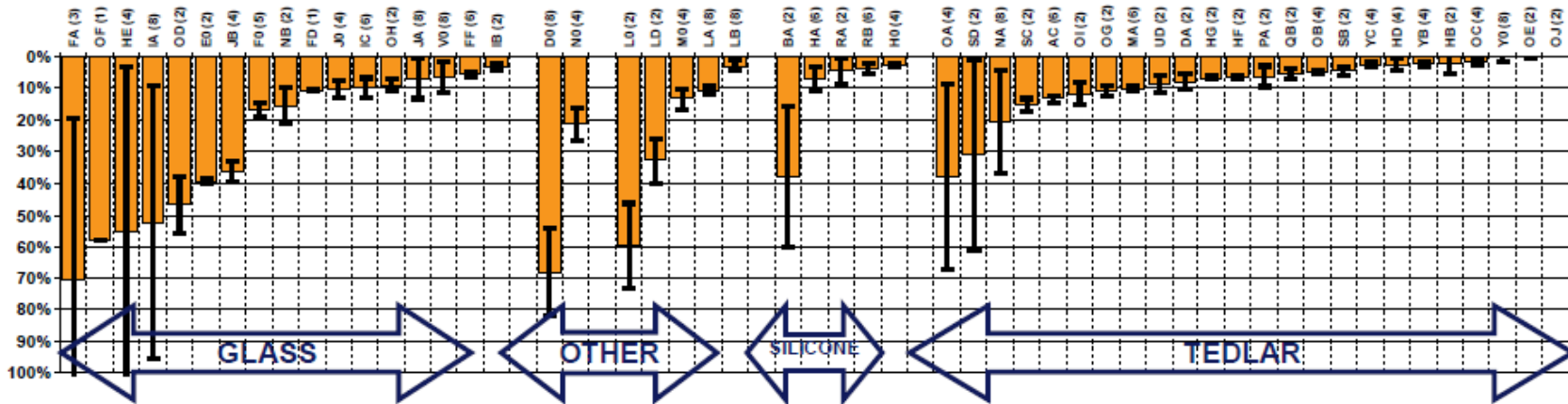

- ❖ Glass-glass modules generally exhibited a greater degradation than glass-polymer construction
- ❖ Large uncertainties though it showed significant difference
- ❖ Published 2009 on 20 year old modules → 30 year old modules!

Side-by-side Comparison of Fielded Modules



P_{max} losses of modules series grouped by back sheet

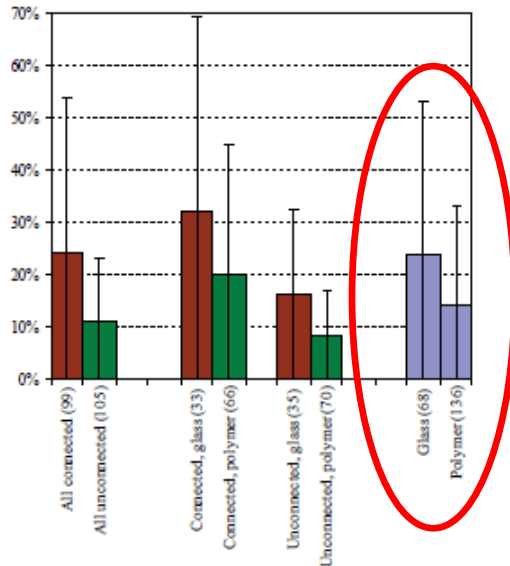
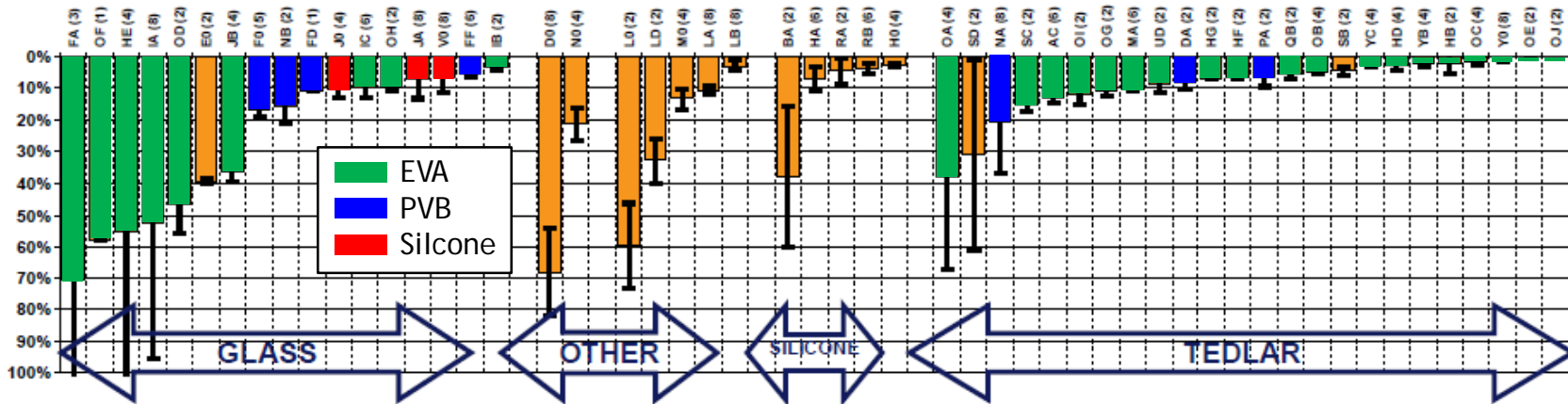

- ❖ Glass-glass modules generally exhibited a greater degradation than glass-polymer construction
- ❖ Large uncertainties though it showed significant difference
- ❖ Published 2009 on 20 year old modules → 30 year old modules!

Side-by-side Comparison of Fielded Modules



P_{max} losses of modules series grouped by back sheet

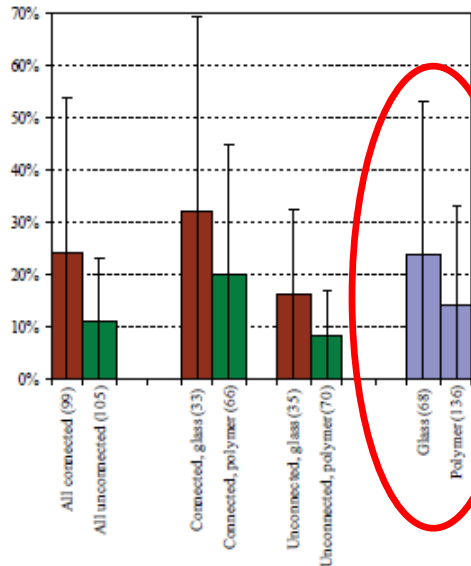
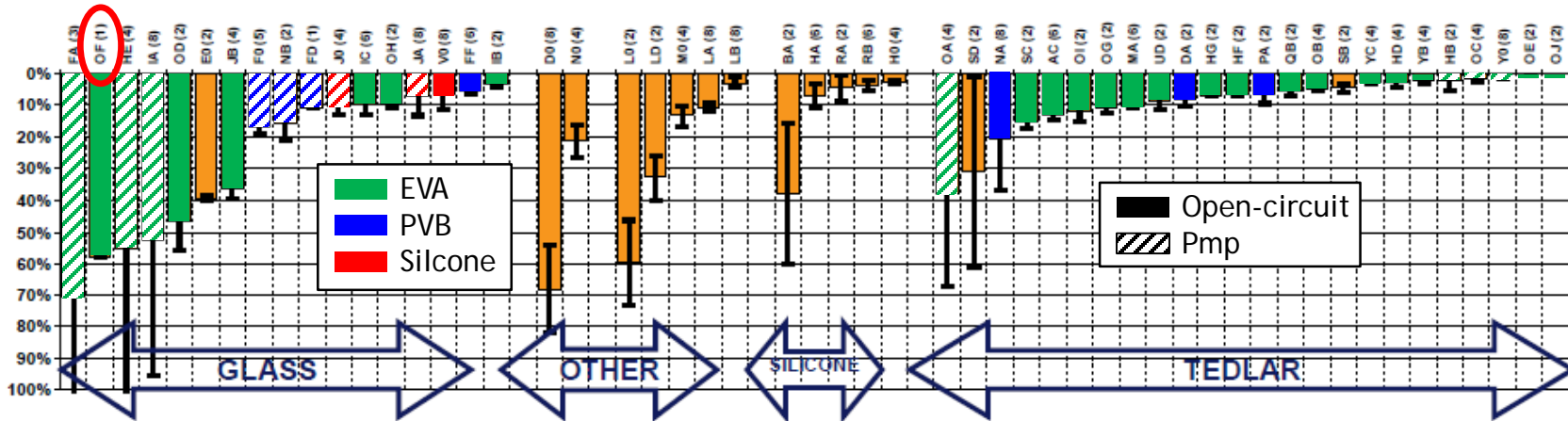

- ❖ Glass-glass modules generally exhibited a greater degradation than glass-polymer construction
- ❖ Large uncertainties though it showed significant difference
- ❖ Published 2009 on 20 year old modules → 30 year old modules!

Study in hot climate shows mixed picture



Model	Average P _{max} Degradation (%/Year)	Order of Statistical Parameters Affected	Order of Statistical Visual Defects	Potential Primary Reasons for P _{max} Degradation
A13 [13 yrs] (glass/polymer)	2.29	FF >> I _{sc} > V _{oc}	DE, SD	Series resistance increase (SBD), DE
B [12 years] (glass/polymer)	1.53	FF >> I _{sc} > V _{oc}	DE, MSW	Series resistance increase (SBD), DE
C12 [12 years] (glass/glass)	0.77	V _{oc} > I _{sc} = FF	DLM, BC, HS	DLM
C4 [4 years] (glass/glass)	4.14	FF > V _{oc} >> I _{sc}	BC, DLM, HS	Unknown
D [12 years] (glass/polymer)	0.83	FF >> I _{sc} = V _{oc}	DE	Series resistance increase (SBD)
E [12 years] (glass/polymer)	0.57	I _{sc} >> FF = V _{oc}	MSW	MSW
F [12 years] (glass/polymer)	1.40	FF >> I _{sc} = V _{oc}	MD, SD	Series resistance increase (SBD)

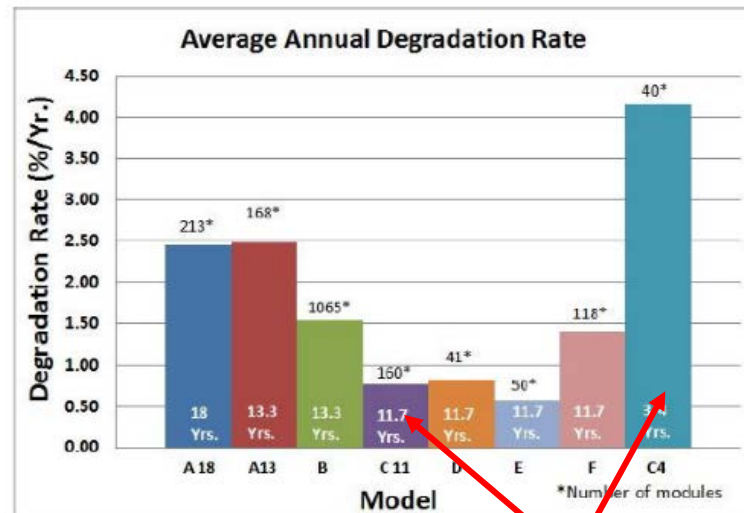

DE: encapsulant discoloration
 SD: seal deterioration
 MSW: minor substrate warping
 DLM: delamination
 HS: hot-spot
 BC: broken cells
 SBD: solder bond deterioration
 MD: meallization discoloration

Glass-glass

- ❖ Not a side-by-side comparison
- ❖ Used nameplate rating, which may have significant uncertainty

Field issues for glass-glass modules



Glass-glass modules, China, 1 year

Sagging



Broken



Glass-glass modules with frame, China, 15 years

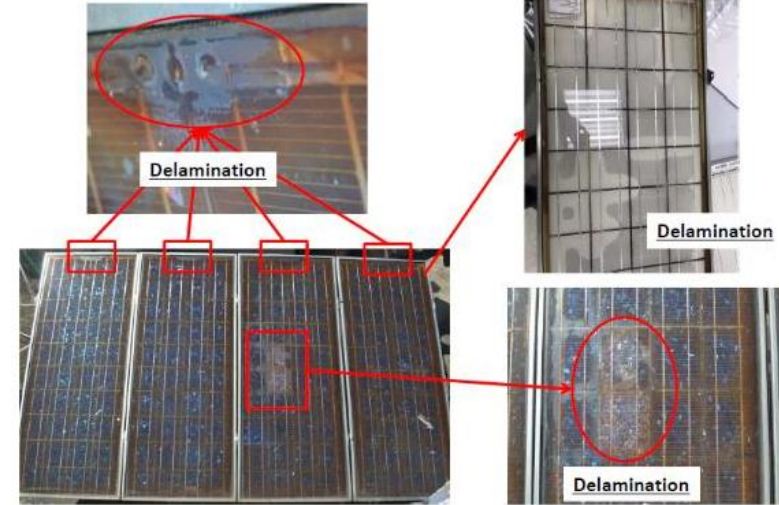

Front and Backside defects

Severe front-side browning & discoloration



Severe and widespread delamination on the rear-side in all modules

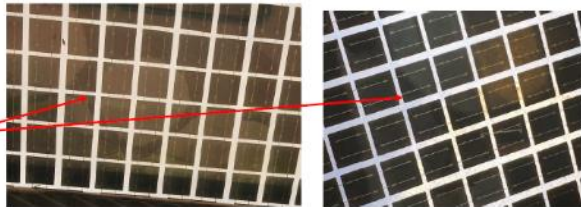

Copyright © DuPont 2017. All rights reserved

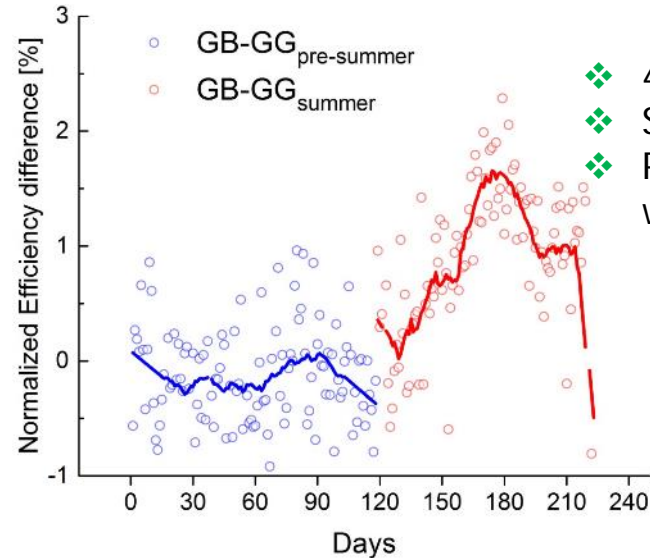

- ❖ 40MW plant in China
- ❖ Small part is glass-glass
- ❖ Part of plant is above water, part above grass

Field issues for glass-glass modules



Glass-glass modules, China, 1 year

Sagging



Broken



Glass-glass modules with frame, China, 15 years

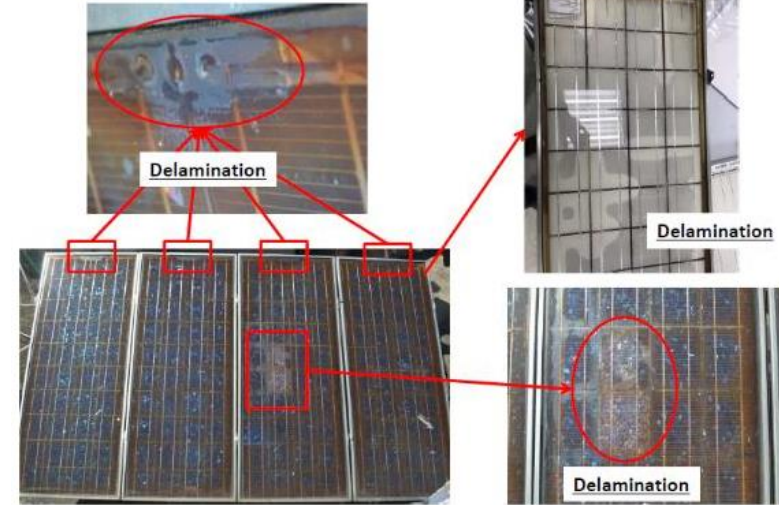

Front and Backside defects

Severe front-side browning & discoloration



Severe and widespread delamination on the rear-side in all modules

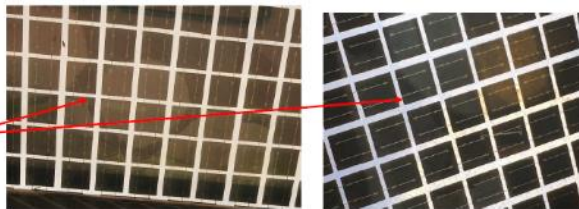

Copyright © DuPont 2017. All rights reserved

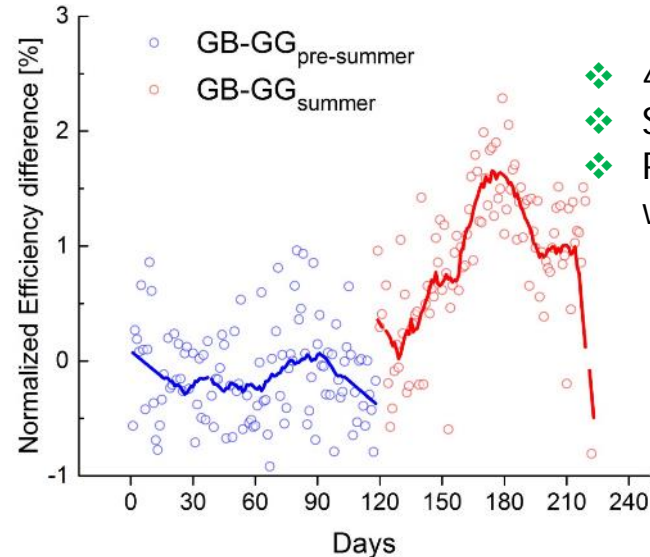

- ❖ 40MW plant in China
- ❖ Small part is glass-glass
- ❖ Part of plant is above water, part above grass

Case closed?

Reason for elevated temperature in glass-glass (bifacial) modules



- Traditional modules usually have **white backsheet**, which reflects radiation incident on the back
- Glass-glass modules **absorb** light incident on the back
- The **increased energy absorption** is the primary cause of elevated operating temperature in glass-glass modules
 - The effect of additional thermal insulation is minimal.¹
 - For bifacial modules one get additional energy!
- For every 30 W m⁻² of waste heat modules typically run 1°C hotter² →

$$1000 \text{ W/m}^2 \times 0.1 \times (1-0.18) / (30 \text{ W m}^{-2} / ^\circ\text{C}) = 2.7 \text{ } ^\circ\text{C elevated temperature}$$

↑
↑
↑

irradiance albedo efficiency

Increased temperature is due primarily to increased rear-side radiation absorbed by the module, not thermal insulation.

¹Silverman et al., JPV, 2018

²Slauch et al. ACS Photonics 2018

Temperature & degradation for different construction modules



Glass-glass

≠ technology, bill of materials

Glass-backsheet

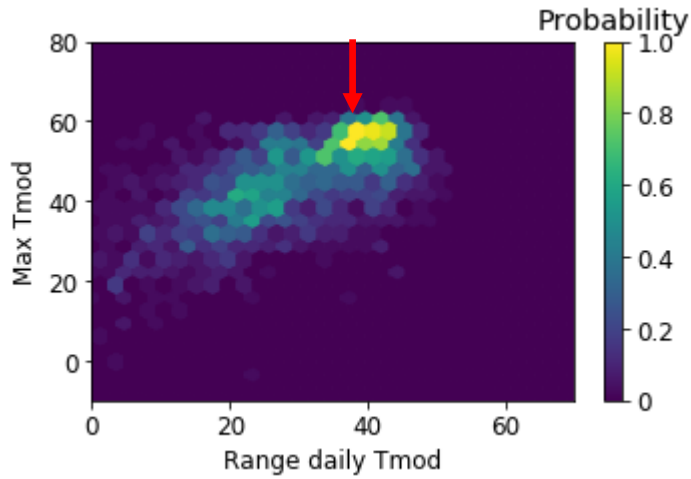

Diff. ca. 2 - 4°

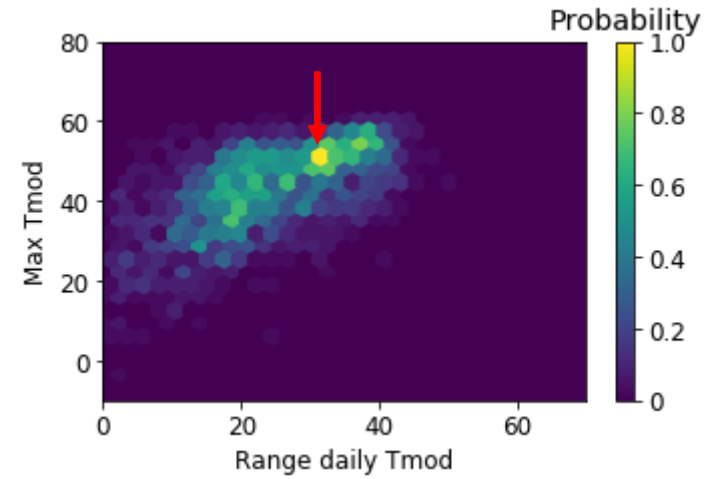

Temperature & degradation for different construction modules



Glass-glass

≠ technology, bill of materials

Glass-backsheet

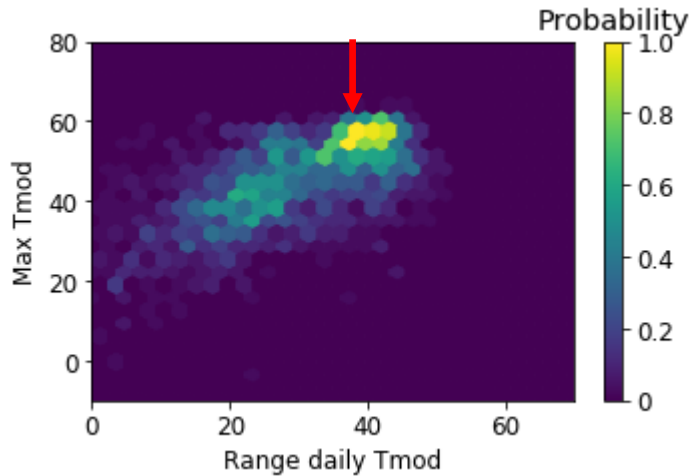

Diff. ca. 2 - 4°

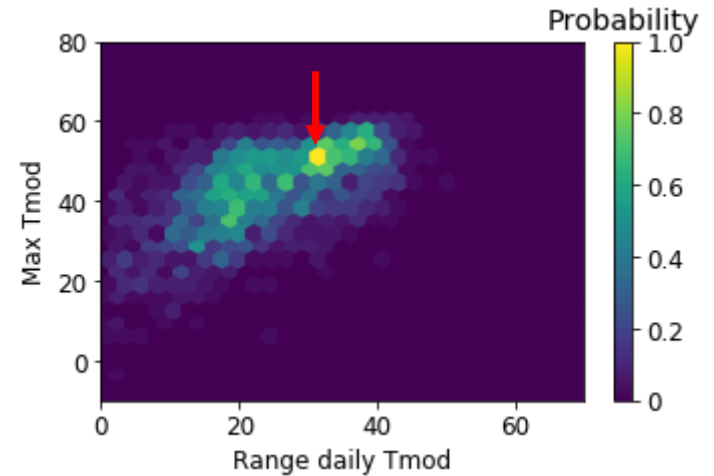

Because in a module there many different mechanisms at work cannot necessarily conclude that this leads to greater degradation!!!

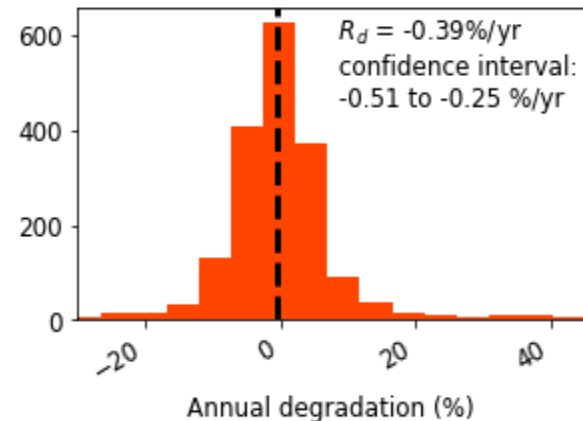
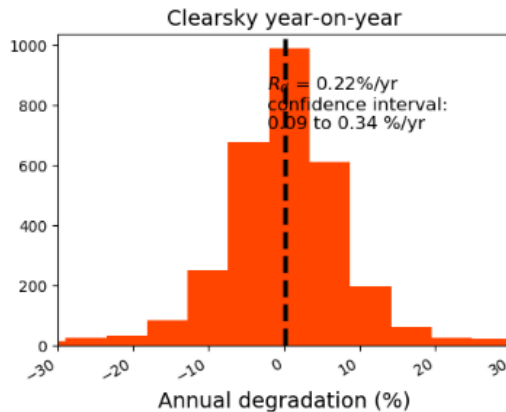



Performance ratio for 16 years

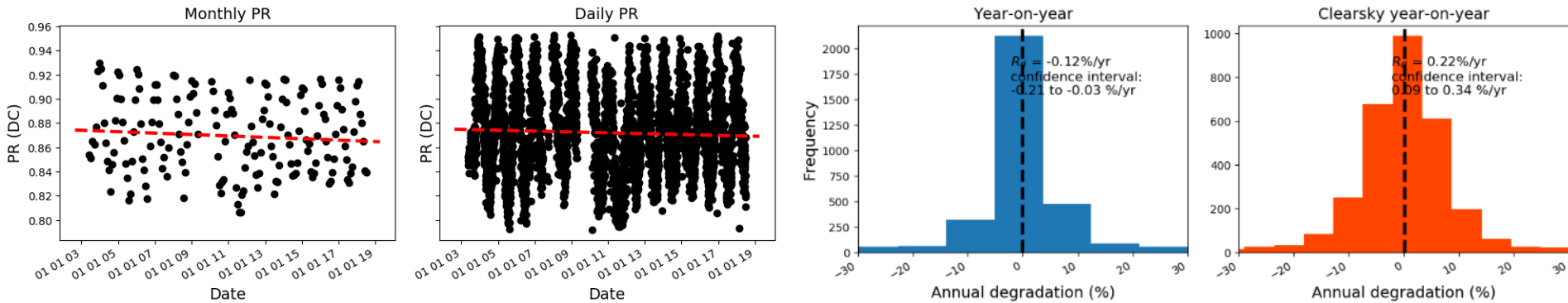

Encapsulant is PVB,
not EVA

Delamination after
ca. 16 years in the
field



Minor delamination
and corrosion at j-box
→ highlights the issue
to have a good j-box
seal



Solar Energy Research Institute of Singapore (SERIS)

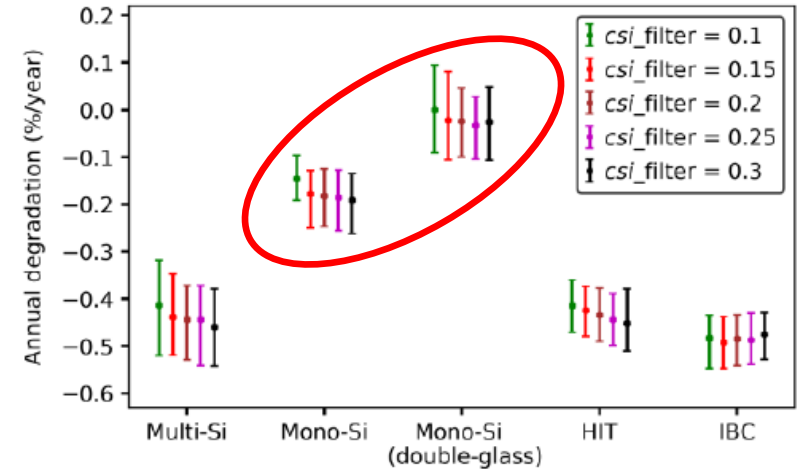

- ❖ 2 modules are from the same manufacturer
- ❖ Not 100% but fairly certain encapsulant is EVA

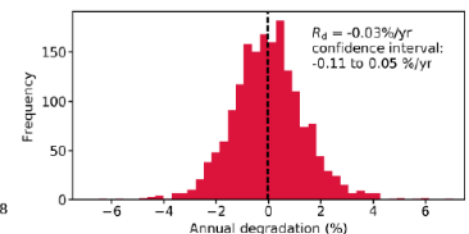
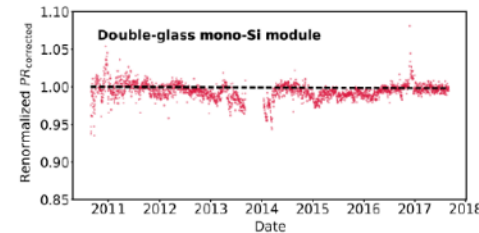
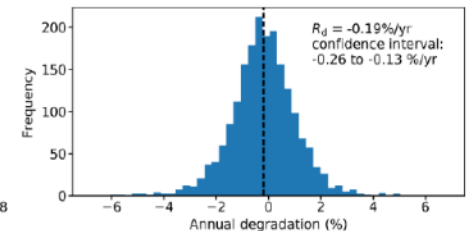
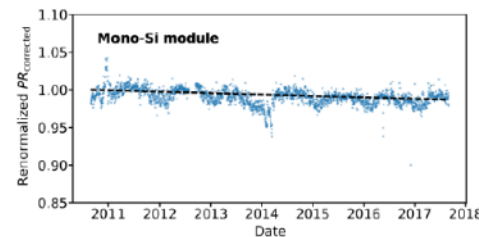



Glass-glass modules need to be considered as a system (design choices interact across the value chain)

- Materials and packaging design
- Manufacturing
- Packing and transport
- Installation
- Performance
- Reliability and lifetime

DuraMAT can help by better understanding materials-related issues for glass-glass modules.

- How to choose and qualify encapsulants for glass-glass modules? (Materials characterization, Module prototyping and testing)
- How to identify new degradation modes? (Materials characterization)
- How to validate and qualify new mounting methods? (Predictive simulation, Field deployment)
- How to validate lower degradation rates? (Field deployment, Module prototyping and testing, Data management and analytics)
- How to quantify cost tradeoffs for glass-glass modules? (Techno-economic analysis)



THE BABY BLUES®



Glass/
backsheet

Glass/
glass



▼▼▼▼▼▼▼▼▼▼
THE BABY BLUES®



Glass/
backsheet

Glass/
glass

Glass/transparent
backsheet, thermally
conductive backsheet
or . . . ?

2018 PV Performance Modeling Workshop (Dec 4-7, 2018) Weihai, China



- Dec 4-5: PV Performance Modeling workshop in Weihai (~\$365)
- Optional PV manufacturing tours (fixed price (~\$665) includes:
 - Dec 4-5 PVPVC Workshop in Weihai
 - Dec 5 (p.m.) Flight from Weihai to Shanghai - bus to Suzhou.
 - Dec 6-7: Guided tours to 3-4 PV manufacturing centers (TBD)
 - Hotel in Suzhou
 - Meals
 - Local transportation
 - PV Manufacturing Tutorial
- Optional Local tour add-on (~\$725):
 - Dec 8: Local tour of cultural sites in Suzhou





Thank you!

jsstein@sandia.gov
dirk.Jordan@nrel.gov