

LCOE Reduction Through Proactively Optimized PV System Monitoring

May 1, 2018

Collaboration



UNIVERSITY OF
CENTRAL FLORIDA

Joe Walters, Hubert Seigneur, Siyu Guo



Ryan Smith



Sandia
National
Laboratories

Josh Stein, C Birk Jones



Jon Pantano



OSIsoft.

Mike Mihuc



SOLAR ENERGY
TECHNOLOGIES OFFICE
U.S. Department Of Energy

Inna Kozinsky, Tassos Golnas

Project Highlights

- Goal –
 - Quantify the contribution PV monitoring systems have in terms of LCOE
- Method-
 - Two PV systems in geographical different areas will be used to investigate power loss events and validate algorithms that can detect those losses
 - Implement those algorithms into a supervisory monitoring system
 - Propagate those algorithms to a utility scale field and determine their success rate in that arena
- Outcome –
 - Comparative results between new algorithms and existing algorithms
 - Improved understanding and contribution to PV's body of knowledge
 - Provide meaningful inputs to the LCOE models that account for PV system monitoring costs

PV Systems @ test sites

- Geographically distinct
 - Albuquerque, NM
 - Cocoa, FL
- Similar arrays for testing
 - nominal performance
- Reference PV systems available
 - Existing arrays at each site, currently operational
 - Used to supplement test systems



PV test sites

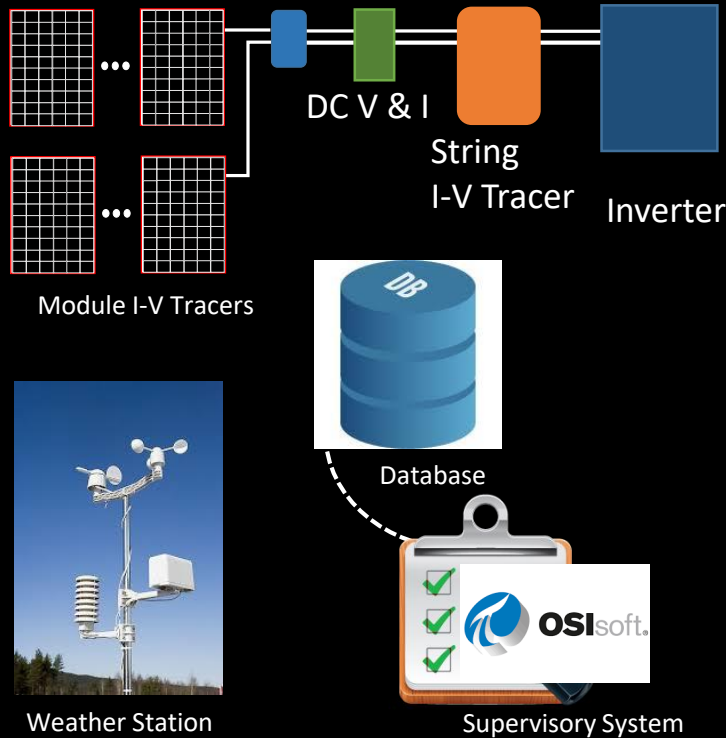

Two strings

Module level I-V tracers (periodically)

DC Voltage & Current (continuously)

String level I-V trace (periodically)

Inverter – dual MPPT

Weather station data time synced

Data communicated to database

Automatic supervisory system

Feedback for power loss, O&M

Methodology

- Apply stressors to PV test array to replicate top 4 failure modes
- Use data set to capture failure signature
 - Module level I-V
 - String level I-V
 - DC parameters
 - Inverter parameters
- Test algorithms against data sets to determine ability to detect power loss
 - Existing algorithms from published research
 - New algorithms developed through this work
- Validate algorithms by performing blind tests
- Roll out validated algorithms to supervisory system in production field
 - Test at utility scale field

A golden statue of a knight on a horse, with a shield featuring the letters 'UCF'. The background is a solid yellow color.

Top four power loss factors String and module level



UCF

Selecting the top four power loss factors

- Failure Modes and Effect Analysis (FMEA)
 - Methods helps quantify power loss events based on importance
 - Analysis results in a risk priority number (RPN)
 - $RPN = \text{Severity} * \text{Occurrence} * \text{Detection}$ [Highest score most concerning]
 - Proposing a slight modification to the RPN formula for PV system
 - $$RPN = \frac{S * D * R}{Q * O}$$
 - S = % power loss from the component affected
 - Q = number of components in the PV system
 - S/Q represents the portion of the system that has power loss
 - O = occurrence in mean time between failures (MTBF)
 - Higher the MTBF, the less impact on the system
 - D = detection – number of plant operation hours to detect the failure
 - R = repair – number of plant operation hours to repair

FMEA – system levels [block diagram]

FMEA Template for Photovoltaic Systems

Version	2	Version Date	18-Apr-18	Author(s)	R. Smith
---------	---	--------------	-----------	-----------	----------

The FMEA attempts to replace qualitative scores for Severity, Occurrence, and Detectability (S, O, D) with normalized quantitative metrics and adds an impact parameter, termed Recovery (R) which captures the time it takes to recover from the failure when energy generation is impacted.

Parameter Definitions

Severity (S) The impact of the failure on the power output of that failure's "level" as described in the graphic.

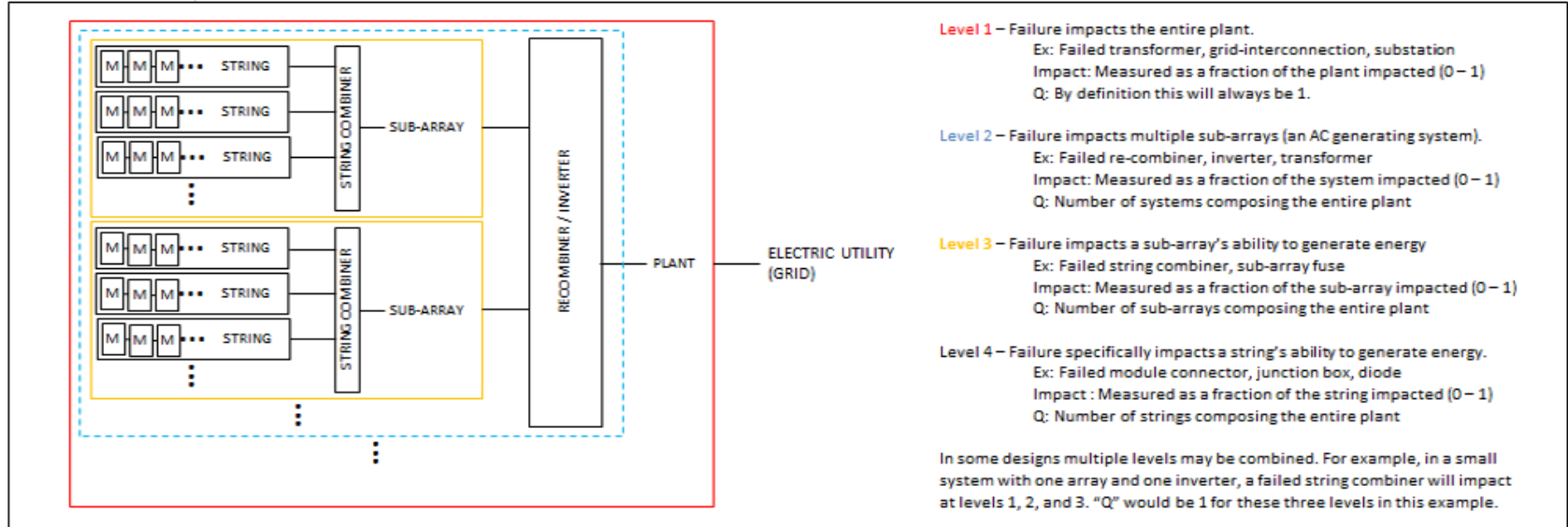

FMEA - example

Severity-Q (Q)	The quantity of units at the indicated level. Ex: A plant composed of 24 sub-arrays of 10-strings each feeding 2 inverters and one grid-interconnection would indicate: Level 1 Failure: Q = 1 since there is, by definition, only one plant. Level 2 Failure: Q = 2 since there are 2 inverters in the plant. Level 3 Failure: Q = 24 since there are 24 sub-arrays in the plant. Level 4 Failure: Q = 240 since there are 240 strings in the plant.
Occurrence (O)	Failure rate in MEAN TIME BETWEEN FAILURES (MTBF) (Ex. An inverter failing once every 6000 hrs: O = 6000)
Detectability (D)	Elapsed operating hours to detect the failure. Note: only count normal plant operation hours.
Recovery (R)	Elapsed operating hours to recover from the failure. Note: only count normal plant operation hours.

Calculation

The calculation provides a score indicating the failure's impact on the ability of the plant to produce energy scaled by the duration of that failure.

$$RPN = \frac{S \cdot D \cdot R}{Q \cdot O}$$

Severity, S, is divided by Q to indicate the relative impact of the failure on the entire plant. In the previous example, a failure which impacts one string entirely (S = 1 and Q = 240) would have an impact 1/240 of the impact of a grid-interconnection failure (S = 1, Q = 1).

FMEA

Failure Mode	Level	Severity (S)	Severity-Q (Q)	Occurrence (O)	Detectability (D)	Recovery (R)	RPN
Ex: Module disconnection	4	1.00	240	10000	80	16	0.00053

In this example the module disconnection impacts one entire string (S=1 at a level 4 event). There are 240 strings in the system (Q=240). The failure has an average MTBF of once every 10000 operating hours (O = 10000). It takes this plant 80 operating hours to detect the failure (10 days assuming 8 operating hours per day; D = 80) and 16 operating hours to have a technician resolve the failure (2 days at 8 operating hours per day; R = 16). RPN = 0.00053

Top four power loss factors –

- Audience participation requested
 - Confidential participation
 - Anonymized results provided to participants
- FMEA worksheet -
 - Requesting you look into your field(s) performance and extract the data
 - Worksheet was developed to quantify participant's issues
- Worksheet developed from
 - reference papers (Colli 2015, Villarini et al 2017)

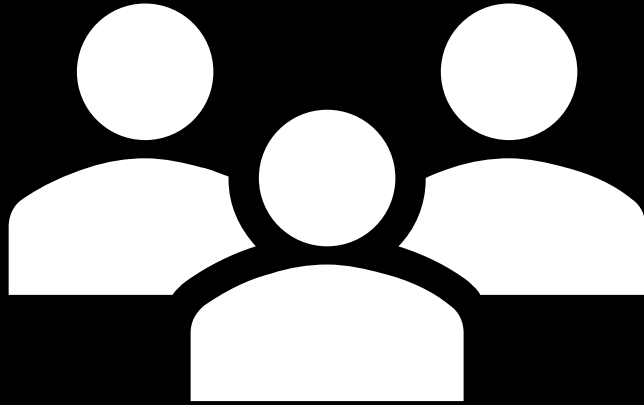

Who will participate in the FMEA ?

Email - joseph.walters@ucf.edu
for the FMEA worksheet

A golden statue of a knight on a horse, with a shield featuring the letters 'UCF'. The statue is set against a solid yellow background. The knight is wearing a helmet with a crest and a shield with the letters 'UCF' on it. The horse is facing left.

Charging forward – Preliminary results



UCF

Early efforts -

C Birk Jones -Sandia

- Shape comparisons
 - Using standard methods at inverter
 - Using Mpp values
 - Using I-V curves
- Identifying non-nominal shapes
- Identifying potential root cause

Siyu Guo -UCF

- Deterministic method
 - Suns Voc
 - I-V (module level)
 - Calculate fundamental parameters
 - Uniform current loss
 - Uniform shunting loss
 - Recombination loss
 - Non uniform shunting loss
 - Series resistance
- Track parameters over time
- Create power loss partition chart

Conventional vs High Resolution PV Monitoring

C Birk Jones -Sandia

- I-V Tracing System

- Data Type:
 - I-V Curves
 - MPP at sweep interval
- Manufacturers:
 - Pordis LLC (string)
 - Stratasense LLC (module)

- Inverter

- Data Type:
 - MPP
- Manufacturers:
 - SMA
 - Fronious
 - Many Others

String Level I-V Curve Tracing

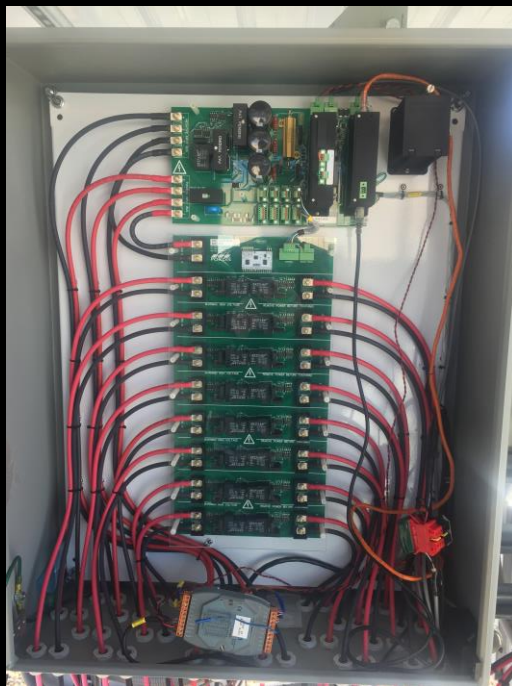

Inverter MPP Data Collection



Energy Yield Output Review

	I-V Curve Tracing System	MPP Data Collection
Interval	5 min – 5 hour	1 min – 15 min
Level	String	MPP Tracker
Energy Estimate	Less Accurate	More Accurate

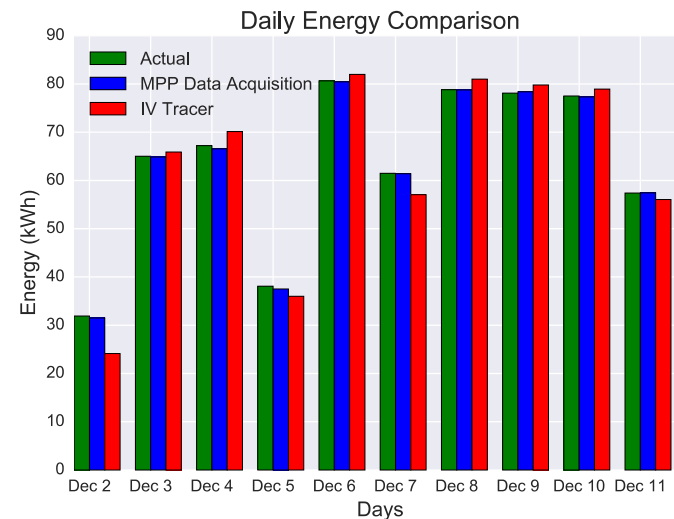
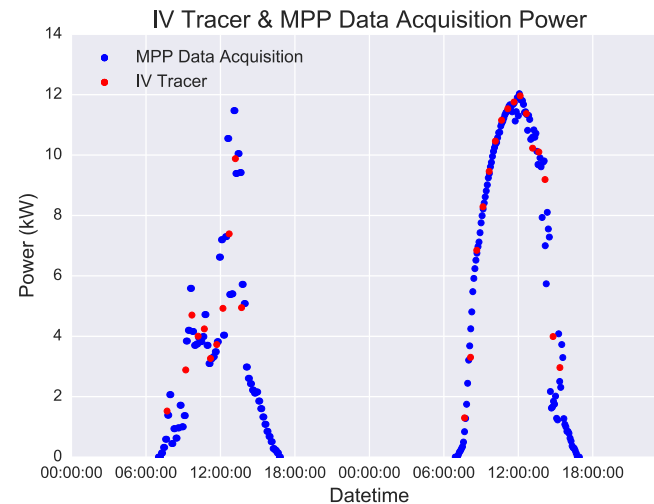

Monitor PV System Performance Hypothesis

- In Situ I-V Curves Support:
 - Detailed Degradation Analysis
 - Root cause analysis
 - Severity analysis
 - Defines location of issue
- MPP Data
 - Basic review
 - Requires deeper dive and onsite investigation

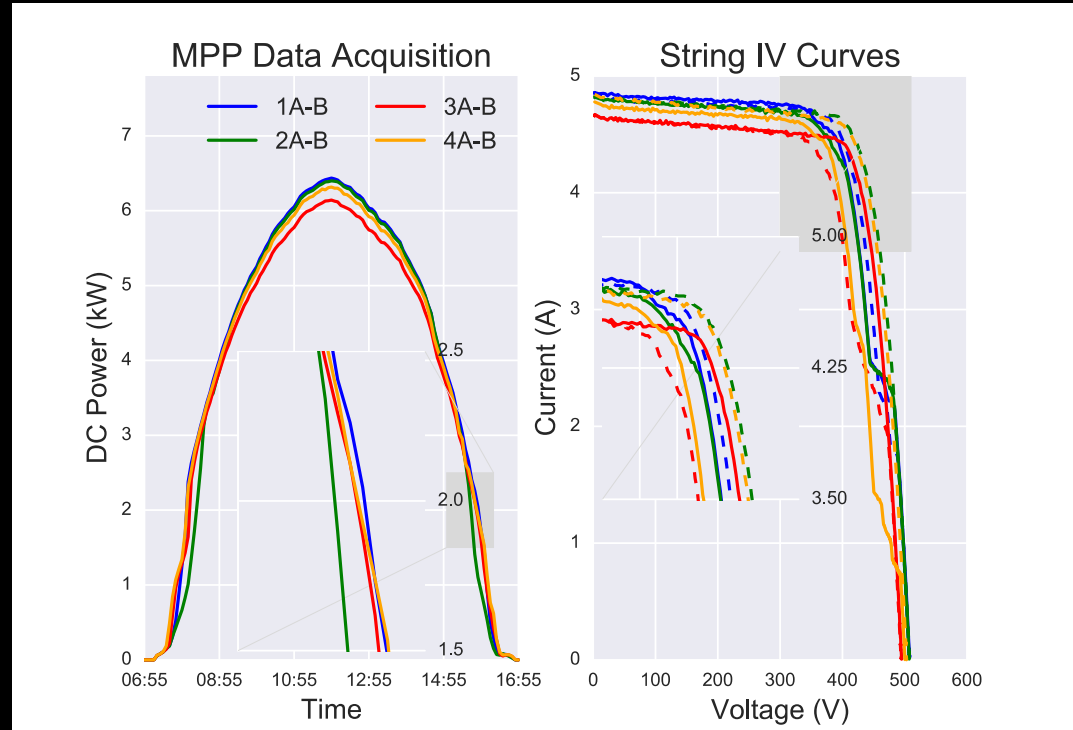

Early effort- deterministic

Siyu Guo -UCF

- Suns-Voc (for the day)
- I-V (same day)
- Calculate baseline
- Compare changes over time
- Create power loss partition chart
 - Example
 - Power Loss Pie Chart
 - 14.6 W from non-uniform shunt
 - 7.9 W from series resistance
 - 1.4 W from uniform shunt
- NIST – 271 kW array data set
 - Currently under evaluation

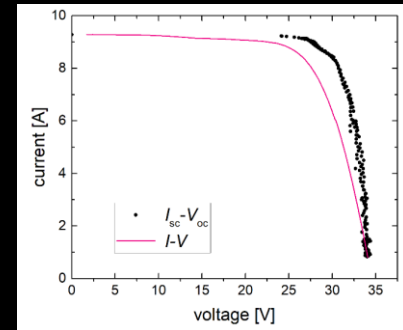
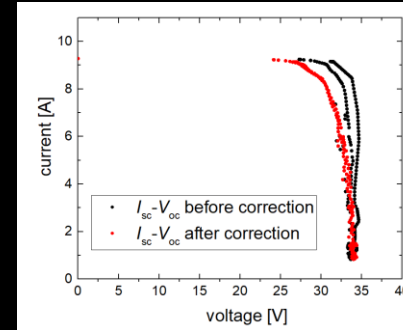

power loss pie chart [W]

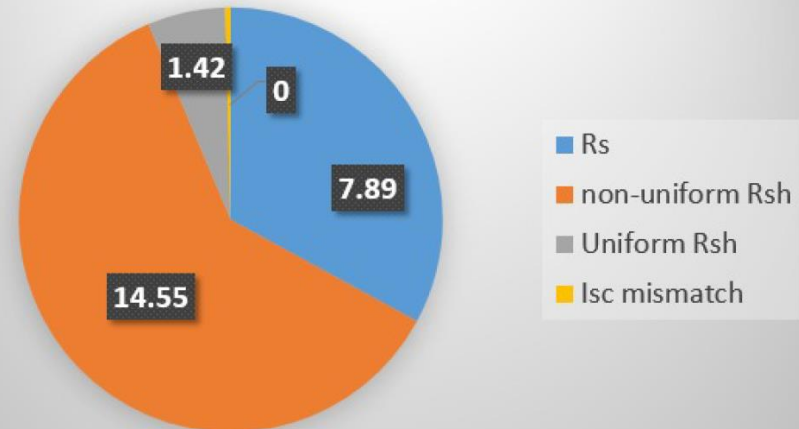

Program Update -

- Collaboration is key
 - Active partners providing valuable input
 - Looking for feedback-
 - FMEA participation specifically
 - Other comments welcome
- Concept
 - Determine the value add of having in situ I-V data
 - Develop and compare power loss detection methods
 - In situ I-V data sets vs. other methods
- Looking forward to significant finding for the next symposium

Interested in this Quest ?

Post Doc position available



This material is based upon work supported by the U.S. Department of Energy's Office of Energy Efficiency and Renewable Energy (EERE) under the Solar Energy Technology Office, Award Number DE-EE0008157.

Disclaimer: "This report was prepared as an account of work sponsored by an agency of the United States Government. Neither the United States Government nor any agency thereof, nor any of their employees, makes any warranty, express or implied, or assumes any legal liability or responsibility for the accuracy, completeness, or usefulness of any information, apparatus, product, or process disclosed, or represents that its use would not infringe privately owned rights. Reference herein to any specific commercial product, process, or service by trade name, trademark, manufacturer, or otherwise does not necessarily constitute or imply its endorsement, recommendation, or favoring by the United States Government or any agency thereof. The views and opinions of authors expressed herein do not necessarily state or reflect those of the United States Government or any agency thereof."

