

# Optimization of Back Reflectors for Bifacial Photovoltaic Modules.

Pedro Jesse Martin

May 14, 2019.

---



ARIZONA STATE UNIVERSITY  
**PHOTOVOLTAIC RELIABILITY LABORATORY**

2019 PV Systems Symposium  
Albuquerque, NM

# Introduction

- Population of the world reaches 7.3 billion, the per capita energy use, especially that of developing countries is expected to increase rapidly
- Imperative that traditional fossil fuel energy systems are replaced by much greener and sustainable renewable energy technologies
- High growth in demand for solar energy technology
- Grid parity without subsidies.
- Uncertain factors affecting the Levelized Cost of Electricity (LCOE) driven by carbon tax, grid control system costs and investment in new transmission.

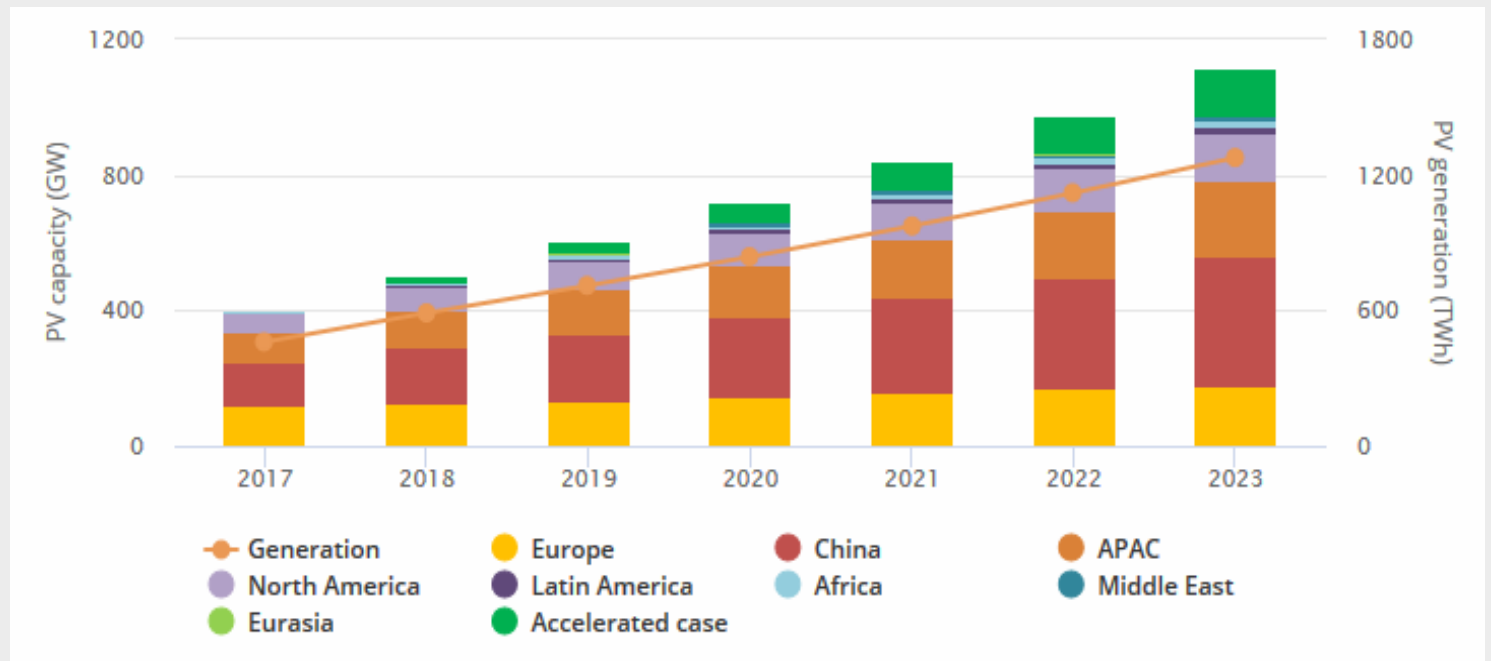

Solar PV generation and cumulative capacity by region (Renewables 2018)

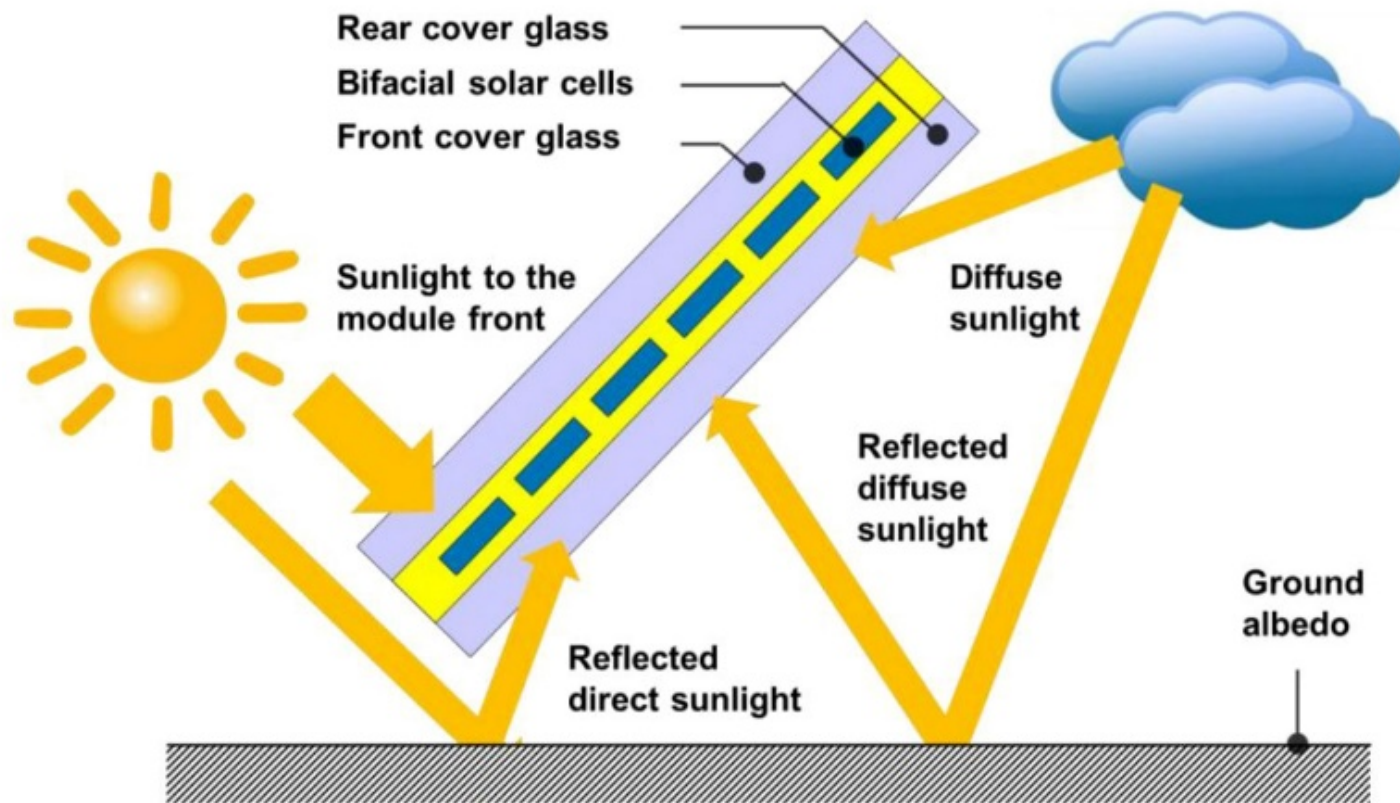

## *Bifacial Photovoltaic Modules?*

- Collect light on both front and rear sides
- Rear side irradiance determined from:
  - Albedo
  - Ground Geometry
  - Self-Shading
  - Module Height
  - Cloud Conditions, etc

### *Improving Bifacial Gain?*

Effect of albedo & module height on  $BG_E$   
 High albedo ground surfaces (0.6+)

# Bifacial PV with Back Reflectors

- 50 – 100% of additional energy for a given tilt direction.
- Importance of the tilt angle or latitude orientation of the modules and ground albedo at each specific site
- Scattering of reflected light over the rear side of the bifacial PV module provides the maximum increase in the overall energy generation
- Variation in solar radiation intensity on rear surface
- A corresponding variation in electricity generation.

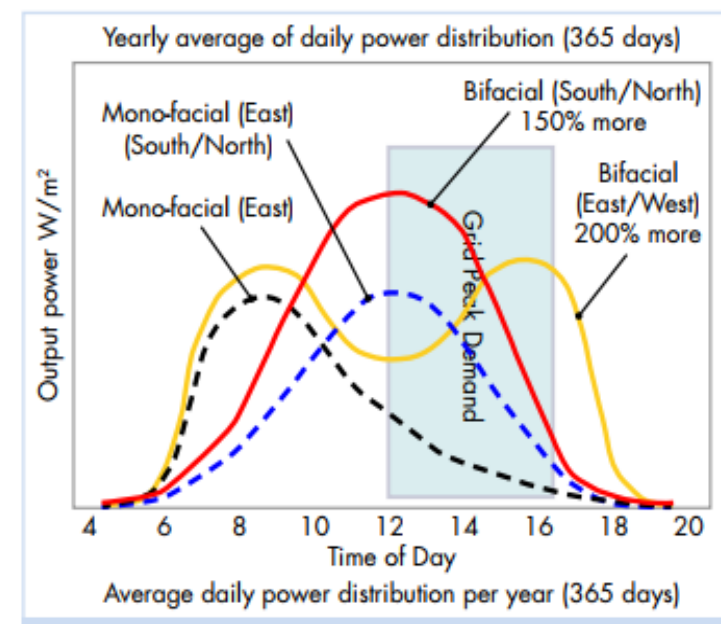

Daily Power Distribution for bifacial modules. [Bolen M., and Nadav E., Bifacial Solar Photovoltaic Modules. 2016]

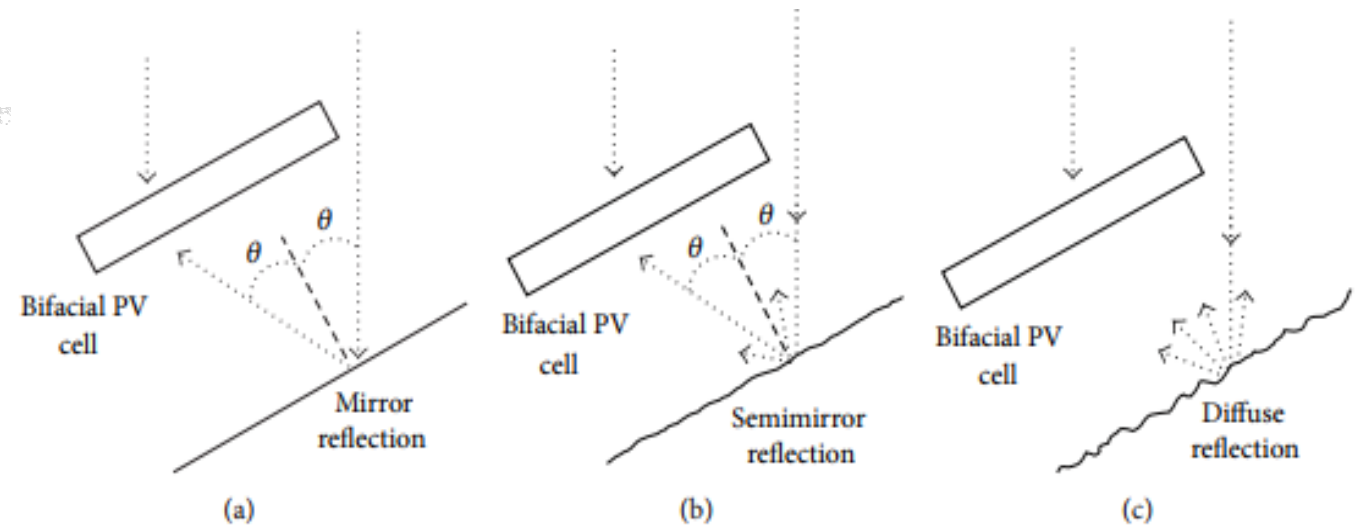

Bifacial PV panel integrated with (a) mirror type reflector (b) semi mirror type reflector and (c) diffuse type reflector [Ooshaksarei, 2013 "Characterization of a Bifacial Photovoltaic Panel Integrated with External Diffuse and Semi mirror Type Reflectors". International Journal of Photoenergy. 2013. 10.1155/2013/465837.

## Objective

- To study the performance of bifacial photovoltaic modules and its dependence on various profiles of stationary reflectors
- To determine the optimum reflector placement distance from the back of the modules.
- To optimize the diffuse reflector surface profile yielding the best PV module performance
- To investigate the effect of reflectors on array row spacing for bifacial installation configuration.

## Approach

- The plan of action for this research project was divided into two major parts.
- The first part of this research study involved experimental investigations with outdoor testing of PV modules mounted with different profiles of stationary back reflectors.
- The second part focused on the effect of stationary reflectors on shading and array row spacing for bifacial power plants.

# Goal

Power of bifacial module with identical **area but densely-packed 60 cells**

=

Power of bifacial module with **identical area but sparsely-packed 48 cells and back reflectors**

Anticipated Benefit:

LCOE reduction by modifying expensive bifacial system with an inclusion of inexpensive back reflectors

Module with  
*sparsely-packed cells*

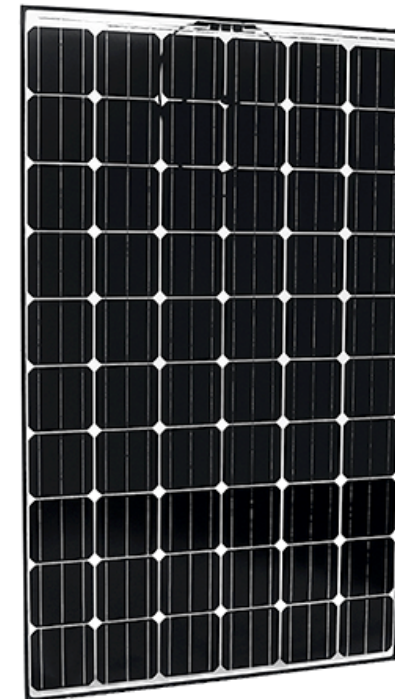
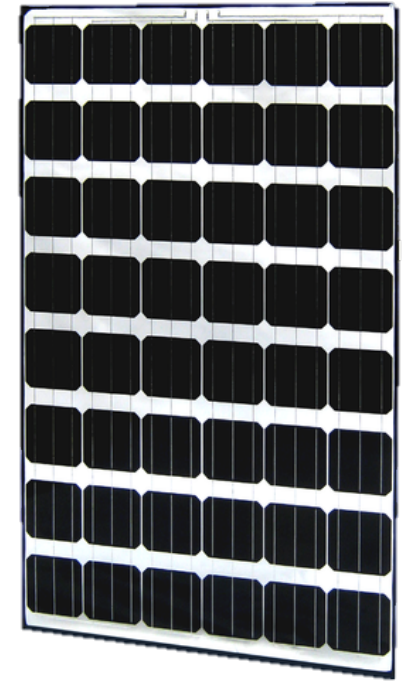

Module with  
*densely-packed cells*

# Methodology

## Experimental Procedure

- Design of reflectors
- System Setup
- Data Collection

## Analytical Modelling

- PVsyst Modelling
- System Advisor Model (SAM)
- MATLAB Coding

# Experimental Method

Design and construct custom reflectors

- Made of aluminum sheets with reflective coating

Mounted behind 48-Cell modules

- Improved back side power contribution

Optimization 1:  
Differing reflector profiles

- Inverted-V
- Inverted-U
- Flat



Optimization 2:  
Differing Cone heights

- 3cm
- 6cm
- 9cm



Optimization 3:  
Differing placement distance

- 25cm
- 50cm
- 75cm
- 100cm

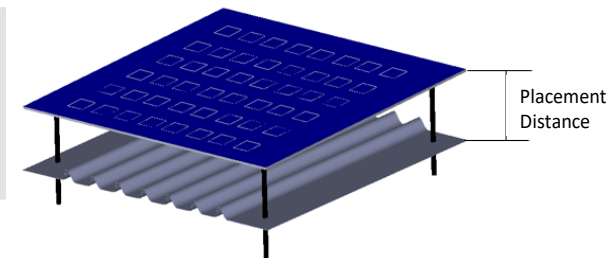



- Constructed with aluminum sheet for “inverted-V” shape
- Half-PVC pipes attached to aluminum sheet for “inverted-U” shape
- Support on back side for stability and to eliminate sagging/warping



Profiles of reflectors utilized

Inverted-V Reflector

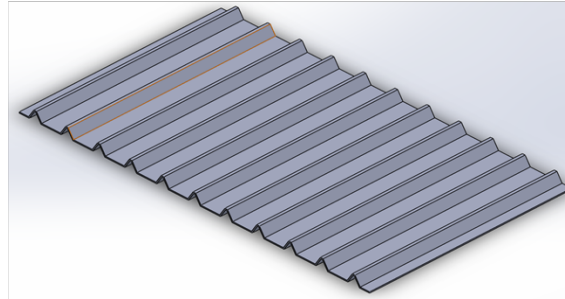

Inverted-U reflector

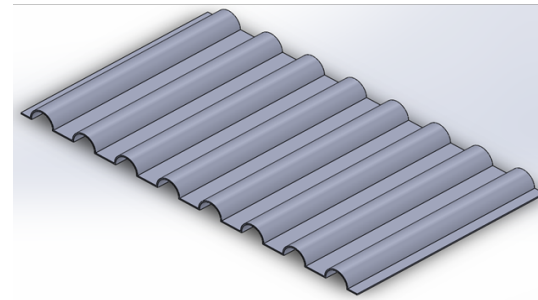

Flat Reflector

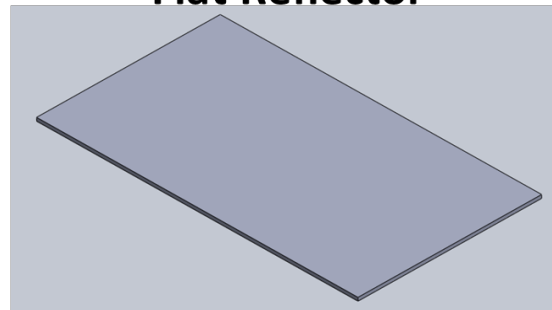

a



b



Mounting Techniques for reflector profiles  
(a) front view (b) side view

# Outdoor Test Setup



**(1)**  
60-cell  
benchmark with  
ground reflection

**(2)**  
48-cell  
benchmark with  
ground reflection

**(3)**  
48-cell  
Module with  
inverted  
U-reflector

**(4)**  
48-cell  
Module with  
inverted  
V-reflector

**(5)**  
48-cell  
Module with  
Flat-reflector

# Analytical Array Spacing Model

- Key component of initial cost and investments made into PV installations
  - ❑ Site Location and sizing
  - ❑ Array design
- With the use of back reflectors for bifacial PV modules, the constraints imposed by ground height clearance will be resolved

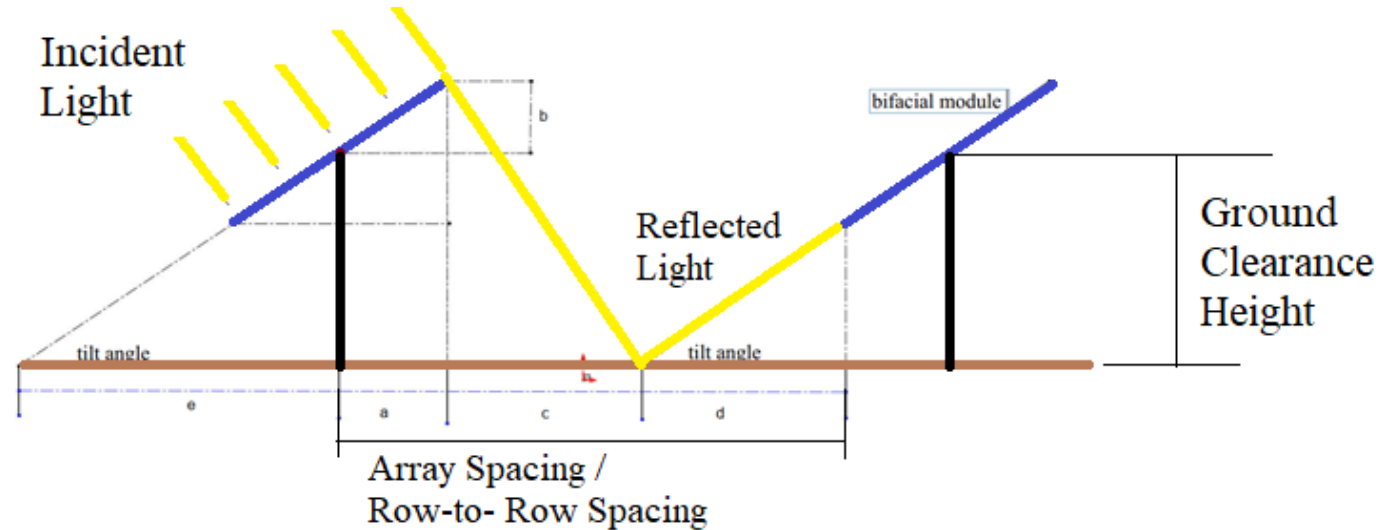

Row to row spacing configuration for bifacial modules without reflectors. (Source: PVsyst / SAM / MATLAB)

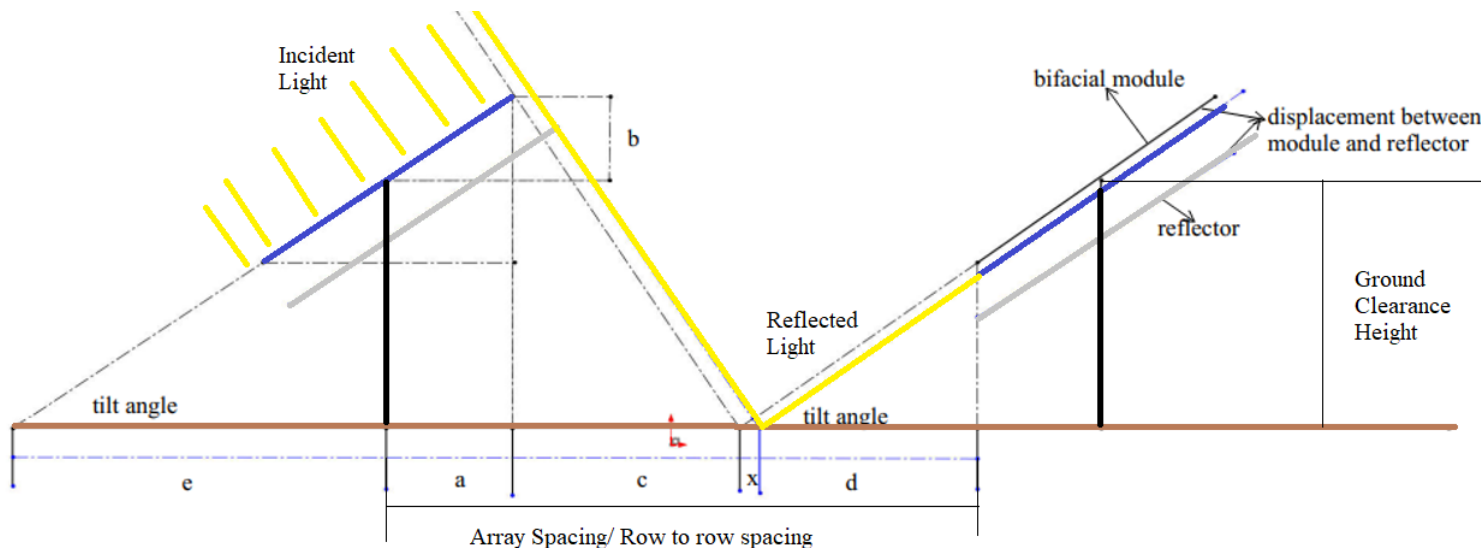

Row to row spacing configuration for bifacial modules with back reflectors. (Source: PVsyst / SAM / MATLAB)

- Bifacial modules are mounted at height to ensure effective collection of ground reflected light.
- Utilizing models from System Advisor Model (SAM), MATLAB and PVsyst, the effect of ground height clearance on the annual energy output, ground cover ratio and optimal row to row spacing

# Results and Findings



I-V Measurements



Irradiance and Temperature Measurements



Output Power Profile



Energy Gain Analysis



Plant Modelling

# Baseline I-V Measurement

- 60-cell module provides additional energy as a result of extra cells there effectively utilizing the incident irradiation on both sides of the module.
- The 48-cells were found out to be identical due to their operating parameters.
- The open circuit voltage,  $V_{oc}$  of the modules were approximately equal. This corresponds with the name plate rating provided
- Difference in current,  $I_{MP}$  is as a result of non-uniform incident irradiation on the rear side of the module and albedo

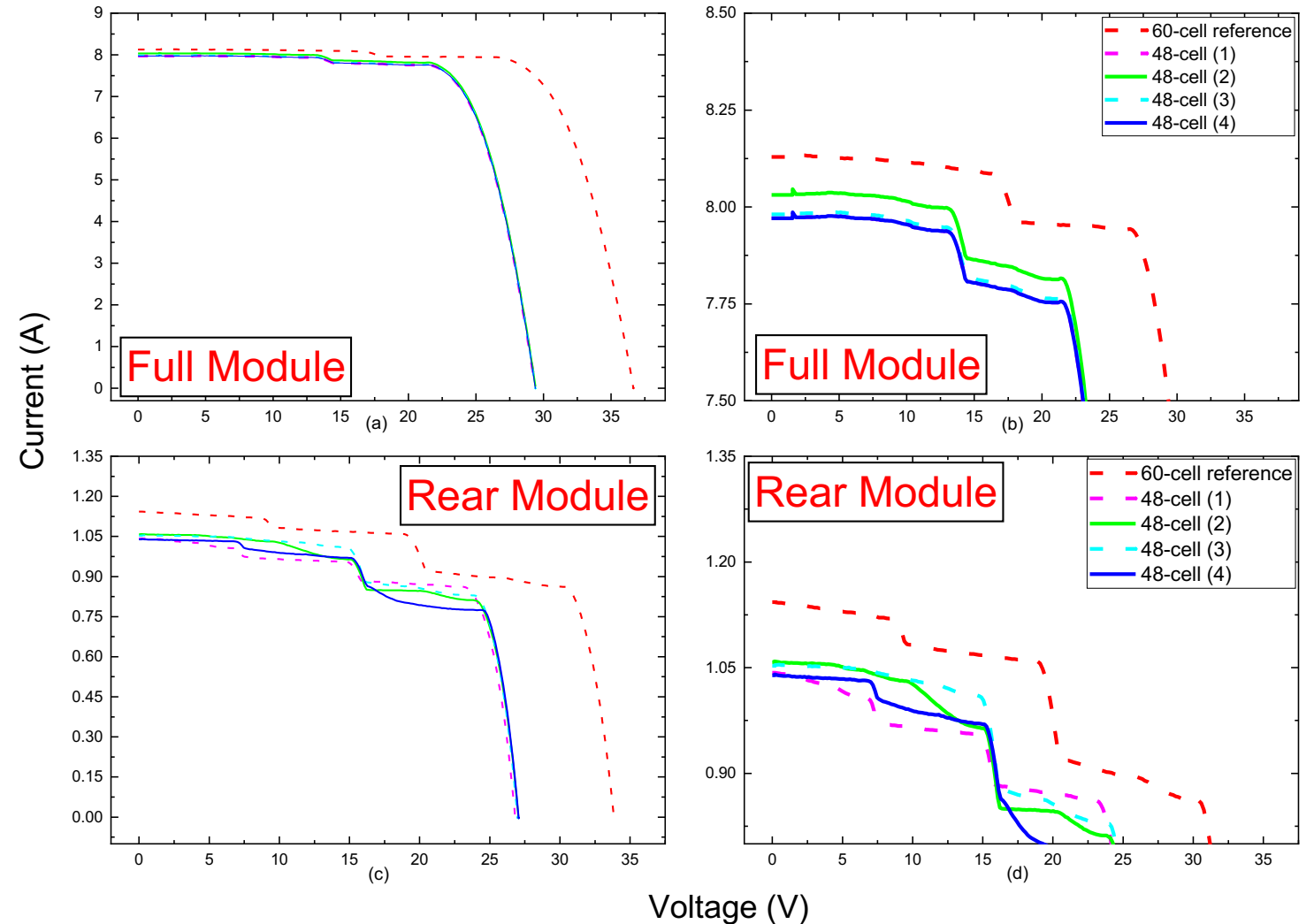

Baseline Measurements in (a) and (c) for full module, in (b) and (d) for rear side of module at solar noon on October 8, 2018.

## Power Correction Factor

- The power output of the 48-cell benchmark module was used to determine the correction coefficients for the power correction and normalization

Correction Factor (C.F) =  $\frac{P_{mp} (48\text{-cell module without reflector})}{P_{mp} (\text{module } x)}$

$P_{mp} (\text{module } x)$

where C.F is the correction coefficient, and  $P_{mp} (\text{module } x)$  is the average power output of the other 48 and 60 cell modules (thus 1,3, 4, or 5). The correction coefficient was evaluated for each module for all readings throughout the solar window.

### Correction Factor Applied

Module	Correction Factor
60-cell benchmark (module 1)	None
48-cell module with inverted U (module 3)	0.996
48-cell module with inverted V (module 4)	0.998
48-cell module with flat reflector (module 5)	0.998

# I-V Measurements

- No change in  $V_{oc}$  of the module
- The overall performance of the bifacial modules with reflectors improved in comparison with the 48-cell bifacial module with no reflector.
- The  $I_{sc}$  value for these modules increased due to the increased incident irradiation on the module.
- This increase in irradiance is attributed to the rear side of the module as the front side of all the modules only utilizes the incident beam insolation
- Steps in the curves indicates the spread of reflected lights on the rear cells of the bifacial module.
- Similar trend in other profiles

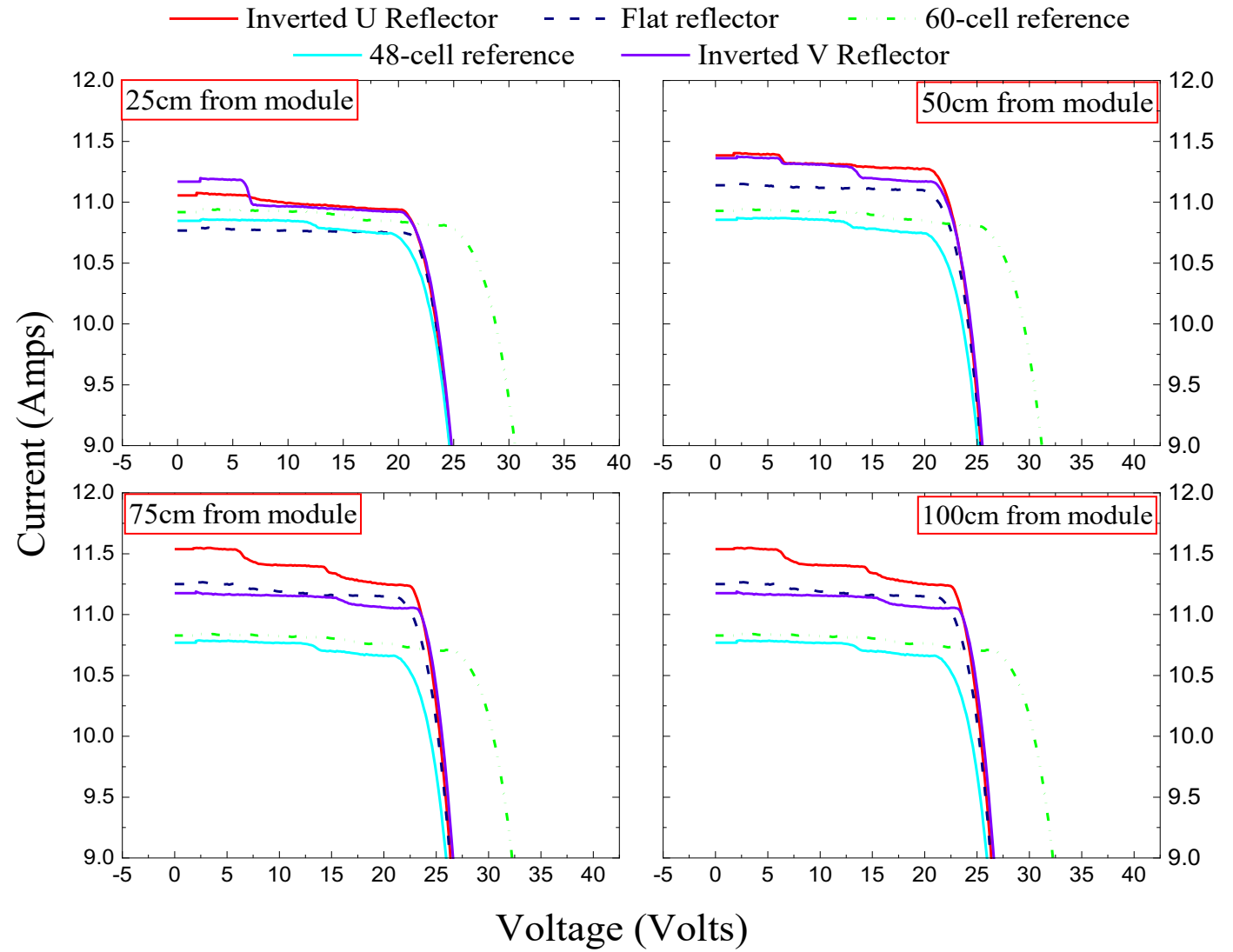

I-V Measurements for 3cm reflector profile at (a) 25cm, (b) 50cm, (c) 75cm and (d) 100cm from the module.

## Placement Distance

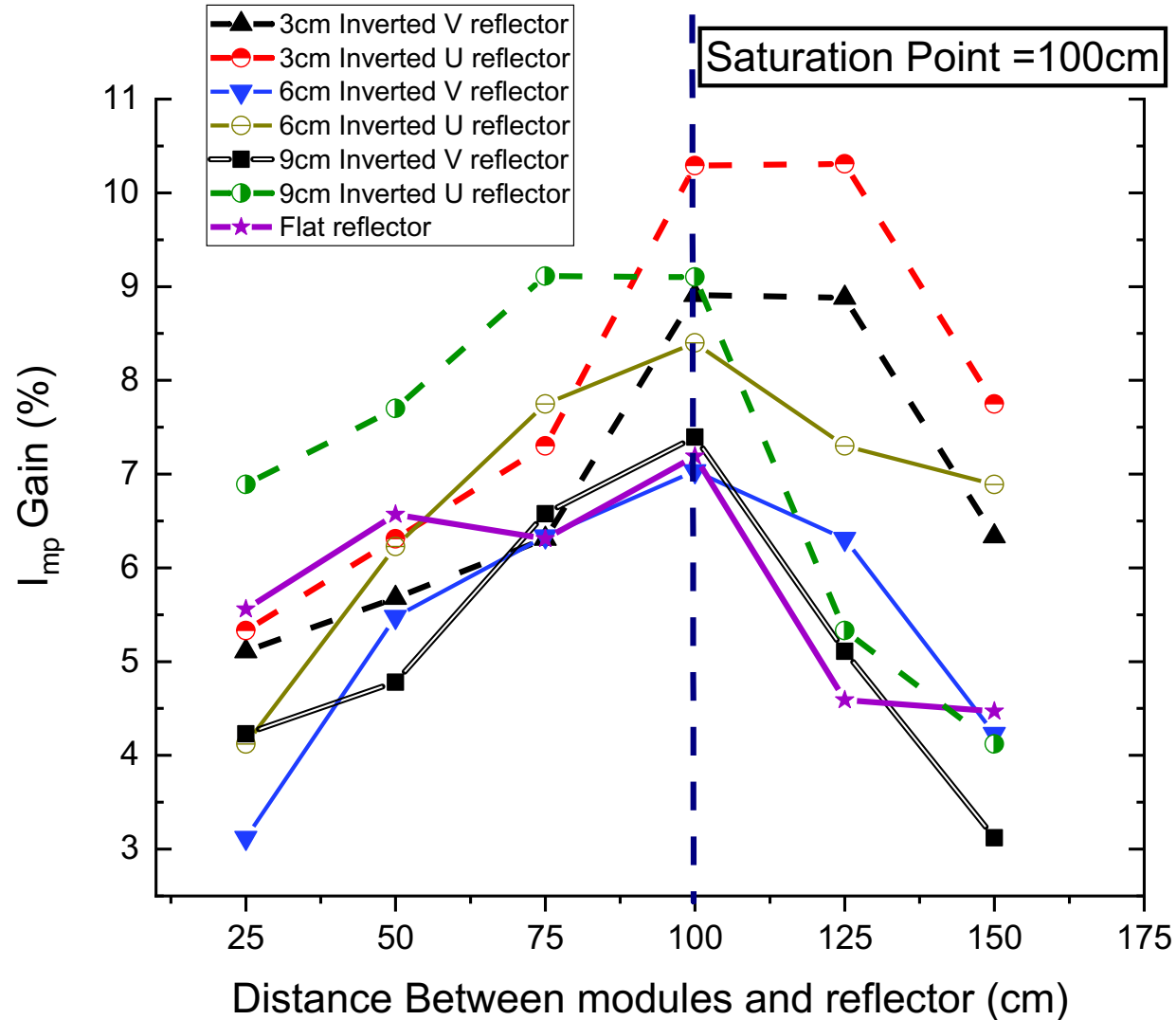

Distance optimization:  $I_{mp}$  gain (%) around solar noon (11:30am-1:30pm from October 21<sup>st</sup> to November 1<sup>st</sup>, 2018) for various reflector profiles

- Inverted U reflector of height 3cm produces more additional power as it provides  $h$
- High gain in the short circuit current of the bifacial module.
- Result of high uniformity in reflected light incident on the rear cells of the modules
- Effective distribution of reflected light on the rear side of the module
- Generally, higher output with increased placement distance



# Irradiance and Temperature Measurement

- High nominal module operating temperature (NMOT) caused as a result of excessive heat can significantly reduce the output of a PV system resulting in unexpected energy loss in an array.
- Solar panel efficiency is affected negatively as its temperature rises.
- Name plate readings of the modules indicated rated performance values at a temperature of 25 degrees C (STC),
- heat can reduce output efficiency by 10-25% depending on their installed location.

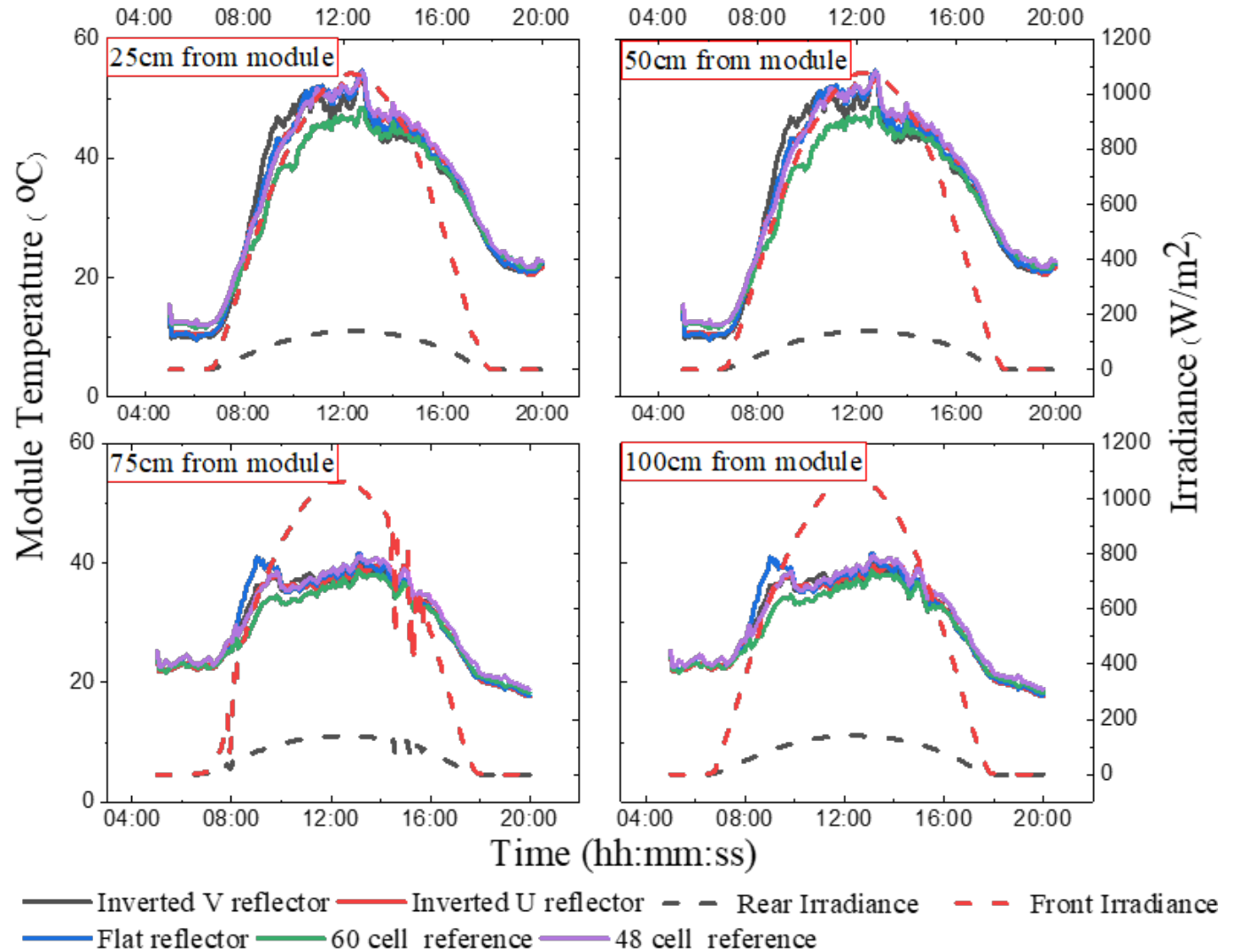

# Thermography of modules (IR imaging)

---

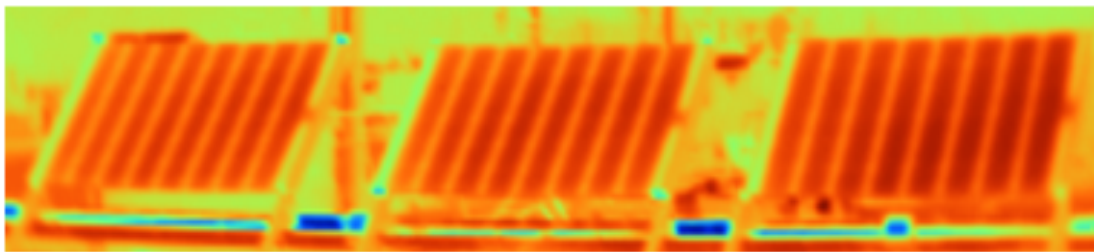
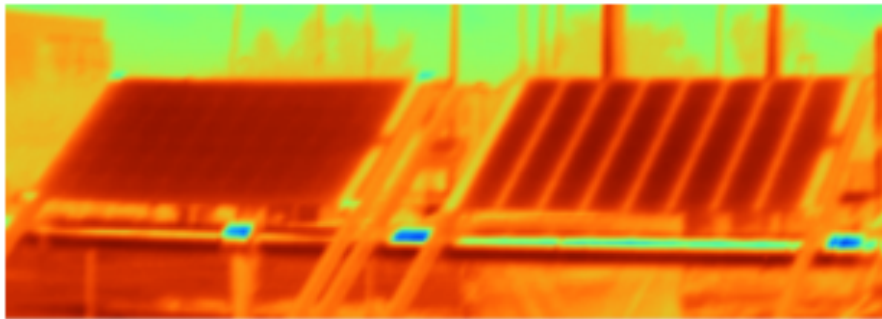

IR graphs for baseline measurements

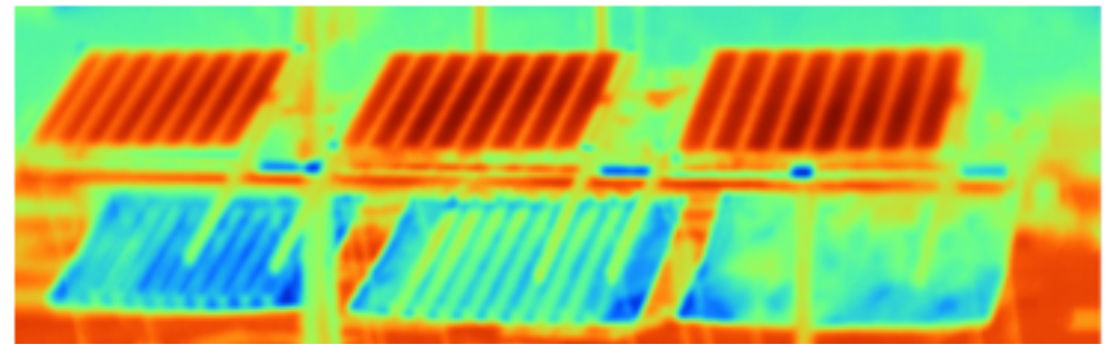
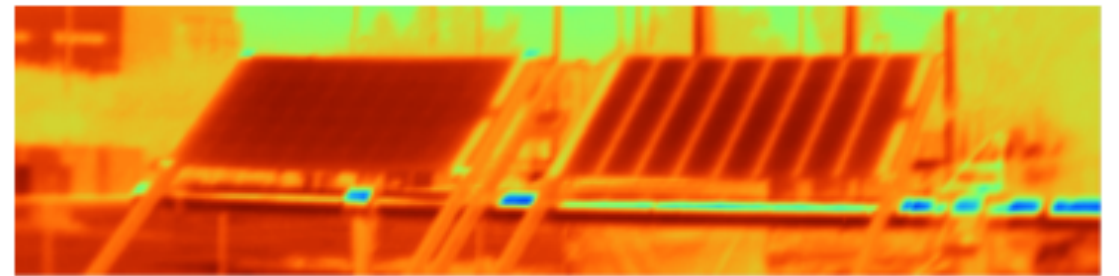

IR graphs for modules with reflectors

# Output Power Profile

- *Rear side of the module experiences about 16-20% of the irradiance on the front side for this setup*
- *10:30am-2:30pm solar Window*
- **Optimized module for the solar window incident irradiance**
- **Less module shadow overlap**
- **Over-illumination on ends of reflector test setup**

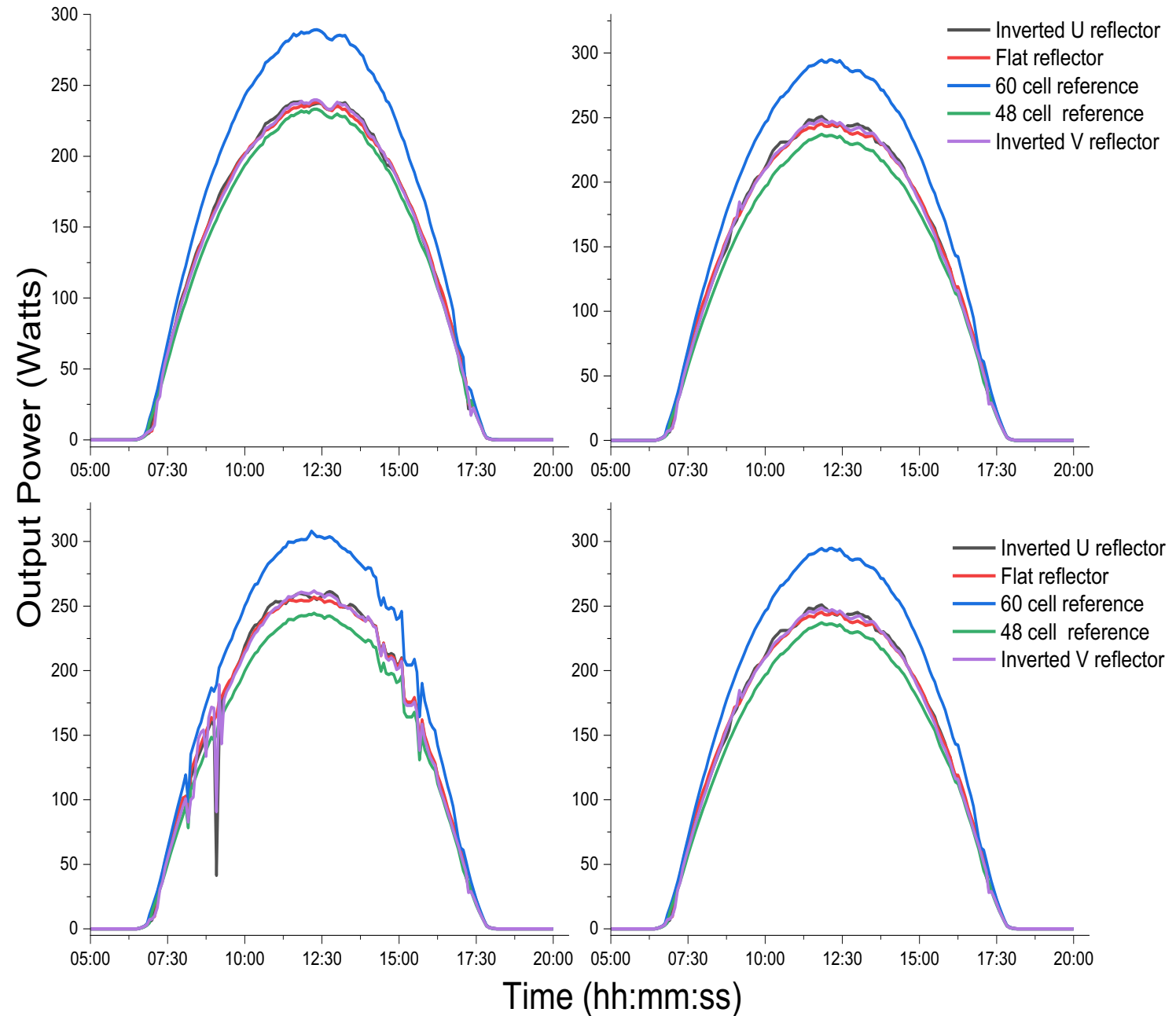

## Percentage Energy Gain

- Averaging the area under the curve of the power graphs over the solar window resulted in gains for modules with reflectors
- Inverted U reflector performed more than half of the additional energy produced by the 60-cell module
- Significant gain could be seen when the reflector is placed at a higher distance from the module.

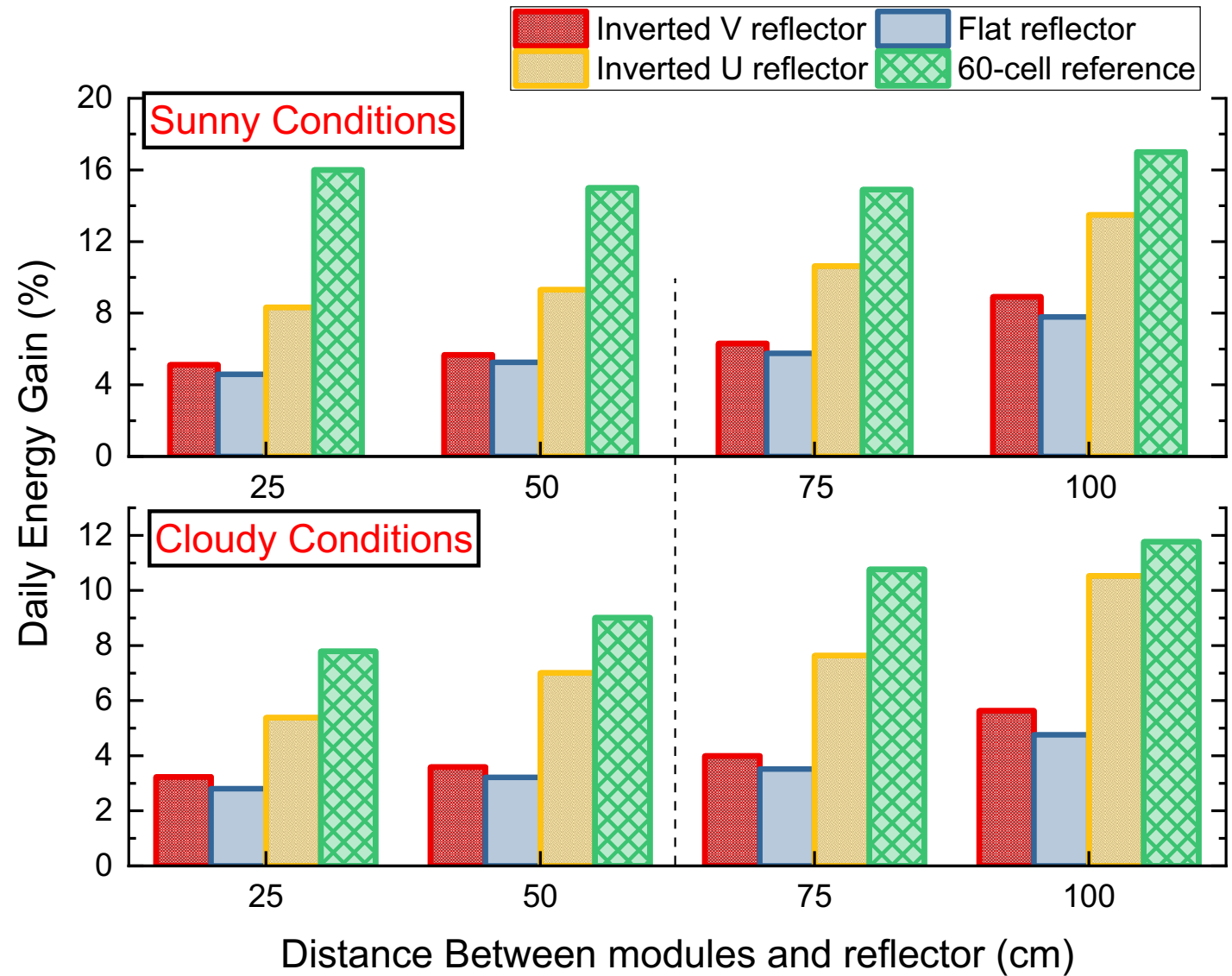

Energy gain for 3cm reflector profile at various distances.

## Percentage Energy Gain Cont'd

- Both the inverted U and V profiles performed poorly for the 6cm cone height.
- The flat reflector in this instance had the higher additional energy
- Nearly half gain in additional energy produced by 60-cell reference module.
- High incidence angle on the reflector surfaces leads to an increase in the non-uniformity of reflected incident on the rear side of the bifacial module.
- Significant gain could be seen when the reflector is placed at a higher distance from the module.

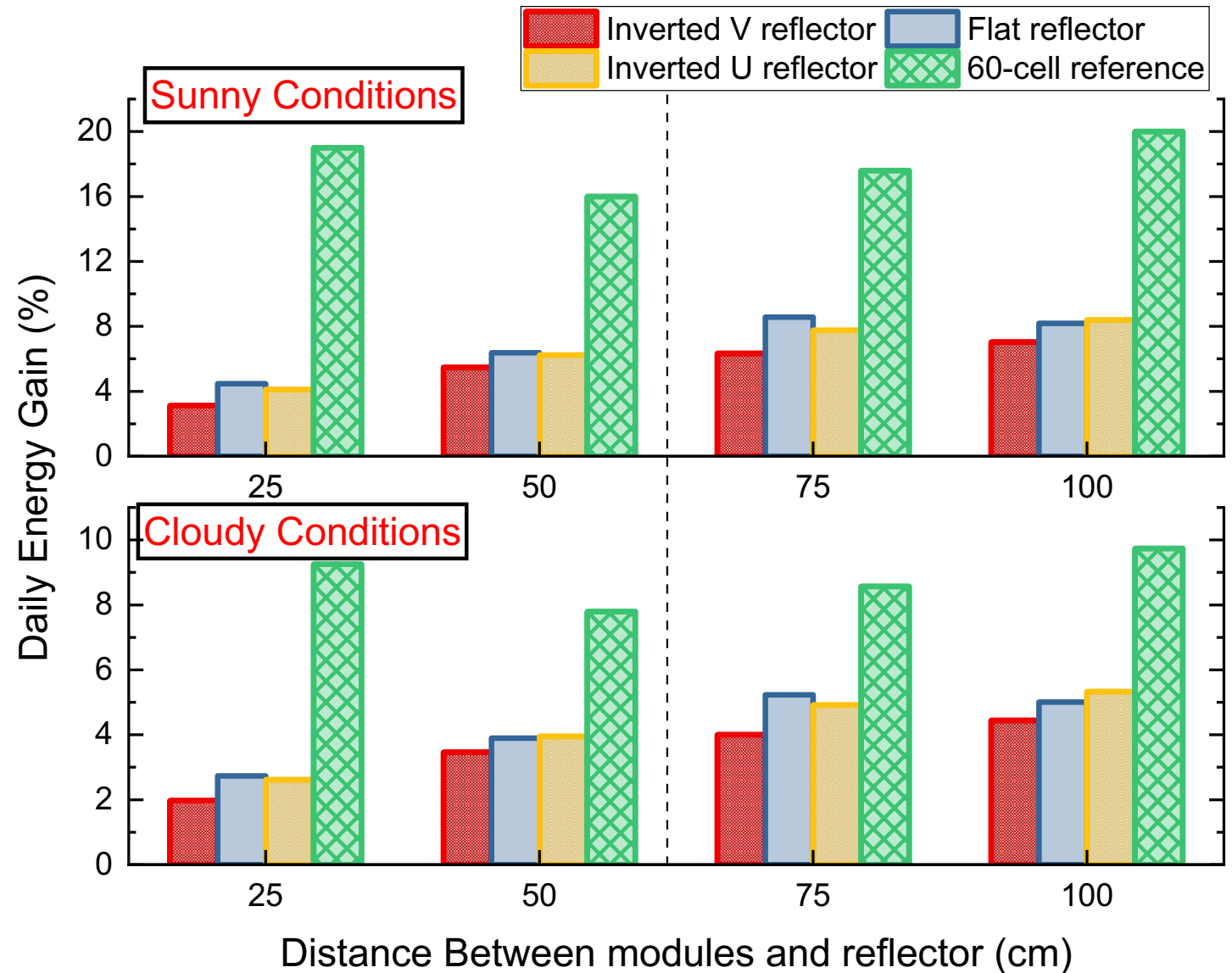

Energy gain for 6cm reflector profile at various distances.

## Percentage Energy Gain Cont'd

- Inverted U reflector performed more than half of the additional energy produced by the 60-cell module
- Inverted V reflector has potential for greater additional energy for the 9cm reflector profile at farther distances from the module
- Significant gain could be seen when the reflector is placed at a higher distance from the module.

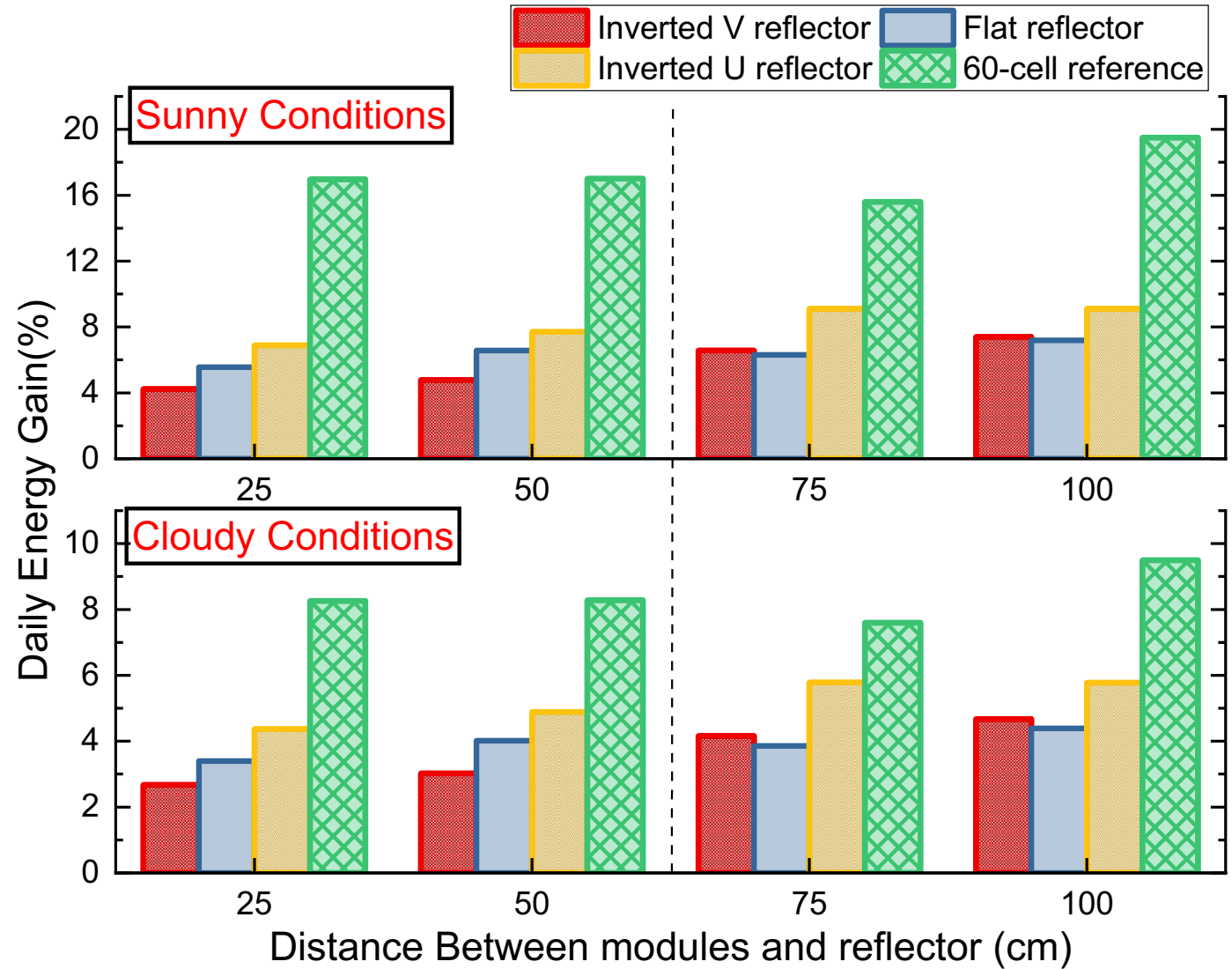

Energy gain for 9cm reflector profile at various distances.

# Bifacial System Modelling

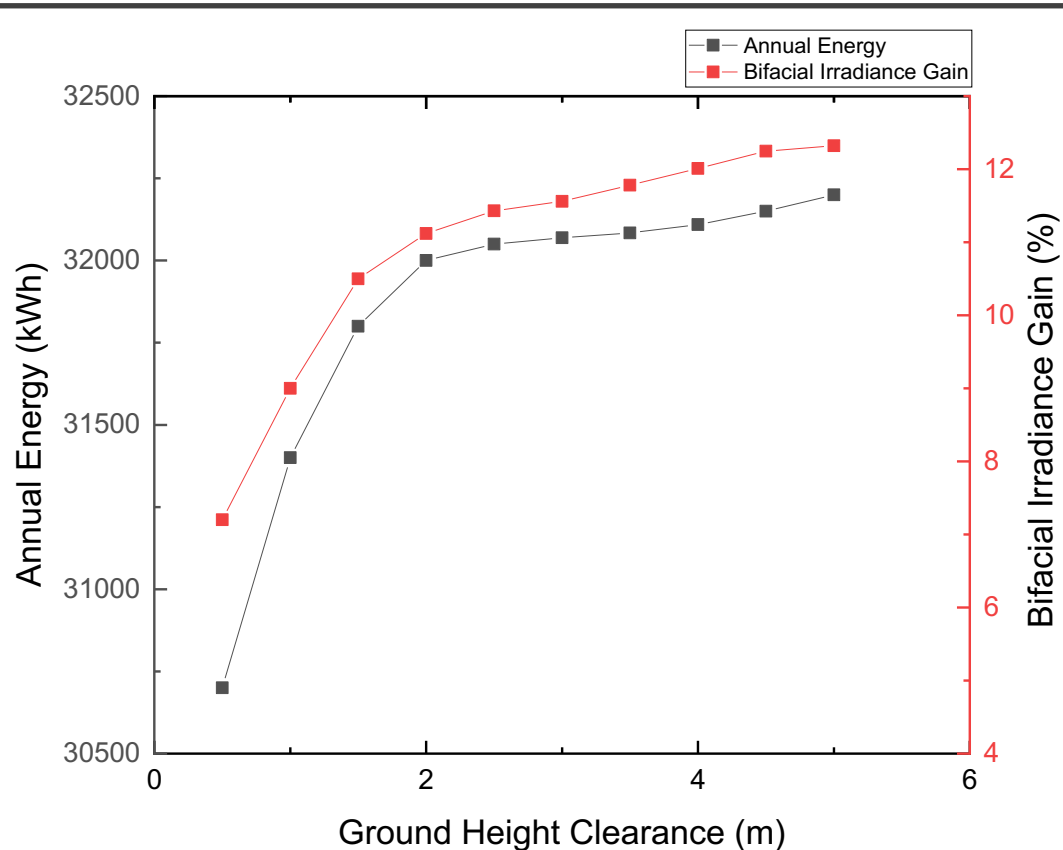

Effect of Ground Height Clearance on Performance of Bifacial Modules

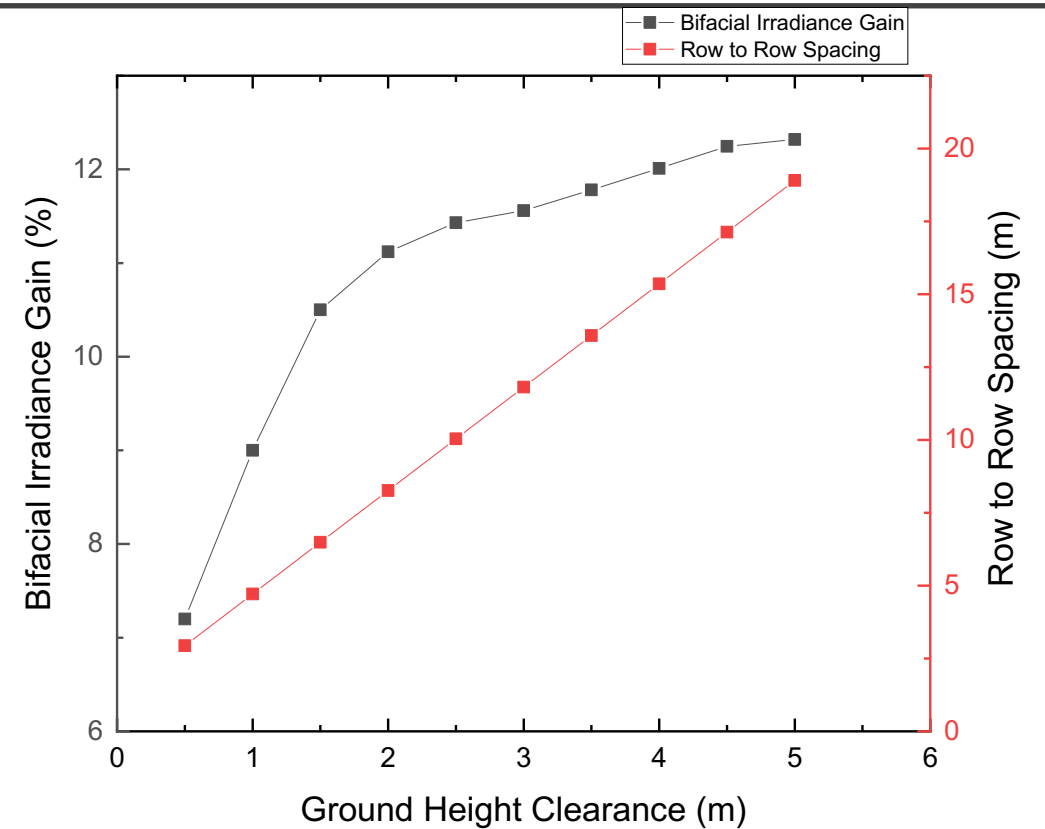

Row spacing for bifacial modules without reflectors

## System Modelling Cont'd

- Increasing ground height clearance increases the annual energy output and the bifacial irradiance gain
- More land size will be needed to put up a design bifacial system since the row to row spacing increases with increasing ground height clearance
- Use of the back reflectors largely reduces the both ground height clearance and the row to row spacing

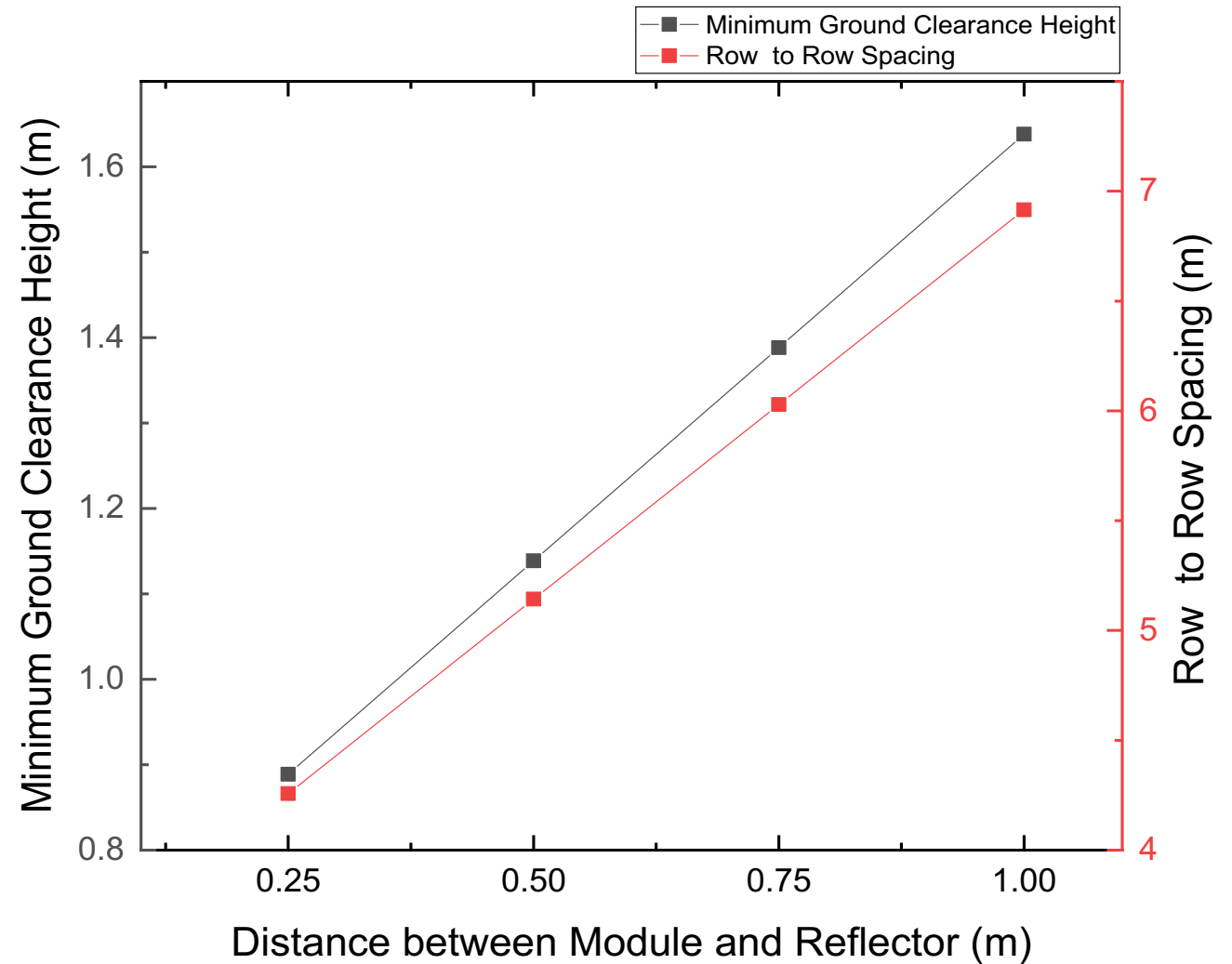

Row spacing for bifacial modules with reflectors  
(Based on calculation done by ASU-PRL using MATLAB developed code).



## System Modelling Cont'd

- Potential for effective land utilization and reduction of material cost by half for the bifacial systems with reflectors
- Indicator of the potential of bifacial PV modules to improve the LCOE of the solar technology and increase its use of bifacial modules instead mono-facial modules.

	60-cell bifacial	48-cell bifacial with Inverted U Reflector placed at 100cm from the module	Takeaway
Energy Gain (%)	18 – 19.5	13.67	Generation of half of additional energy with 50% less additional cells
Cell Temperature Gradient (°C)	0.5	.45	No significant rise in NMOT
Ground Clearance Height (m)	3	1.67	Reduction of column height by nearly half leading to material cost savings
Land Size (Row to Row spacing) m	11.85	7	40% reduction in land size required.

# Conclusion



The bifacial technology with back reflectors represent a paradigm shift in reducing the levelized cost of electricity (LCOE) of solar installations



Gain of 11-14% of additional energy with back reflector over a 48-cell reference module with ground reflection (16-19% for 60-cell bifacial module with ground reflection)



Performance of bifacial modules largely depend on the profile and displacement of the back reflector.



Not only does a reflector increase energy output of the bifacial reflector, the material and land costs involved in setting up bifacial systems are largely reduced



Material and land cost can be potentially reduced up to 50% with use of back reflectors.