

# “光伏+” 储能微网电站设计要点分析

## “PV+” Energy Storage Microgrid Power Plant Design Analysis



董晓青 Xiaoqing Dong



# 目录 Agenda

1

**储能系统作用及应用类型**

Energy Storage System: Function & Type

2

**储能并网系统及案例** Energy Storage  
Grid Connected System & Case

3

**储能微网系统及案例** Energy Storage  
Microgrid Connected System & Case

4

**物理储能系统及案例** Physical Energy S  
Storage System & Case

# 储能系统作用及应用类型

## Energy Storage System: Function & Type

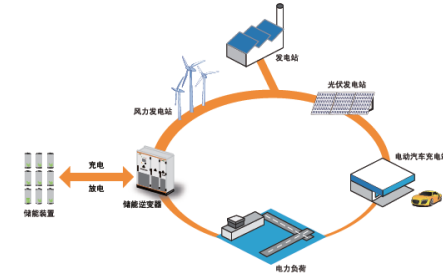

### ■ 储能系统作用 Energy Storage System Function

■ 在新能源发电中，风能、太阳能发电具有间歇性、不稳定性的特点。储能设备可与新能源进行配套，主要作用包含：Among all renewable energies, wind and solar is known for their intermittence and instability. Combine the energy storage equipment and renewable energy, which:

1) 跟踪计划出力，减少弃风弃光对发电企业影响 Track power generation, and mitigate the negative effect to power plant when wind or solar power generation is limited

通过储能系统快速充放电能力，快速响应电网系统对新能源系统出力的要求，在新能源限发时储能系统进行充电，解除限发后储能系统放电，减少弃风弃光对发电企业影响。Fast charge and discharge in the energy storage systems realize the quick response in the municipal grid. Energy storage system starts to charge when renewable energy is off, and vice versa, which mitigate the negative effect to power plant.

2) 优化新能源电站出力，平抑波动 Optimize renewable energy power plant and suppress fluctuation

通过储能系统快速充放电，实现大功率动态调节，减少外部条件对新能源发电系统影响，实现新能源电力可控性，减少对电网冲击。Through the rapid charge and discharge in energy storage system, to achieve high-power dynamic adjustment, reduce the impact on the renewable energy system caused by external conditions, to achieve the controllability of the renewable energy power, and reduce the impact onto the power grid.

3) 微电网系统可靠供电保证 Reliable power supply of the microgrid system

光伏、风电等新能源发电单元通过与储能系统结合，可以可靠地解决偏远无电地区的供电问题。Renewable energy units like PV and wind combining with the energy storage systems can

### ■ 储能技术的应用类型 Applications of Energy storage

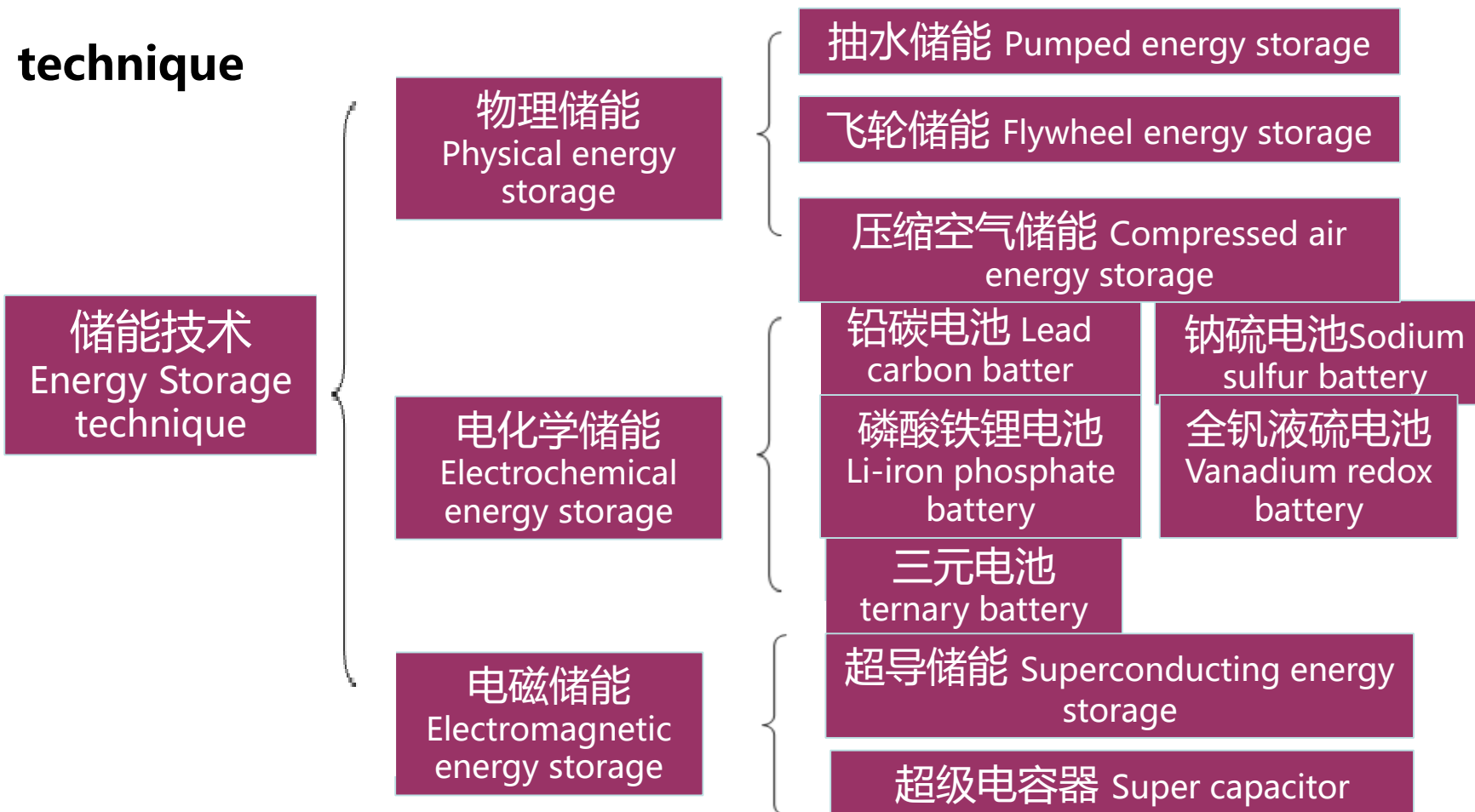

### 物理储能 Physical energy storage

**抽水储能：**在满足地质和水文条件的前提下，分别设置上下游水库，在电力负荷低谷时，将低地势下水库的水抽到上游水库，将电能转换为势能；在用电高峰时，再将上游水库的水释放，驱动水轮机组发电，将势能转换为电能。 Pumped energy storage: meeting the geological and hydrological conditions, set up upstream and downstream reservoirs respectively, when the power load in the valley, draw the downstream reservoir water up to the upstream reservoir, and convert the electrical energy into potential energy; when in the peak time, release the water in the upstream reservoir and drive turbine, converting the potential energy into electricity.

**优点：**目前比较成熟的大容量储能技术，低成本，使用寿命长，转换效率70%以上；

**Advantages:** mature large-capacity energy storage technology, low cost, long life, conversion efficiency > 70%

**缺点：**受地理位置制约且建设施工周期较长。

**Disadvantages:** subject to geographical constraints and longer construction time.

**压缩空气储能：**在电力负荷低谷时，利用电能将空气压缩储存于储气室内部；在用电高峰时，高压空气从储气室释放进入燃气轮机同燃料一起燃烧后驱动涡轮机带动发电机输出电能。 Compressed air energy storage: When the power load is low, use electricity to compress the air and store in the air storage chamber; when in peak time, high pressure air from the storage chamber enter the turbine, combusting with fuel and drive the turbine to drive generator to generate power

**优点：**可实现规模储能，建设成本及运营成本低，使用寿命长；

**Advantages:** large scale energy storage achievable, low constructional and operational costs, long service life

**缺点：**需要大容量储气装置，建设厂址条件有限，充放电过程依靠燃料，效率一般60%。

**Disadvantages:** need large-capacity air storage device, construction-site conditions limited, charge and discharge process rely on fuel, efficiency around 60%

**飞轮储能：**利用电能驱动电动机带动飞轮高速旋转储能，当需要放电时，高速旋转的飞轮转子降低转

子，通过发电机的发电功能将动能转换为电能释放，实现放电功能。 Flywheel energy storage: use electricity to drive motor and flywheel to high speed to store energy, when in the need of discharge, slow down the rotor and convert the kinetic energy to electricity, and discharge.

**特点：**对飞轮、轴承工艺要求较高（耐高温、转速快），断电无法长时间储存，转换效率较低； Features: high requirements on the

1

# 储能系统作用及应用类型

## Energy Storage System: Function & Type

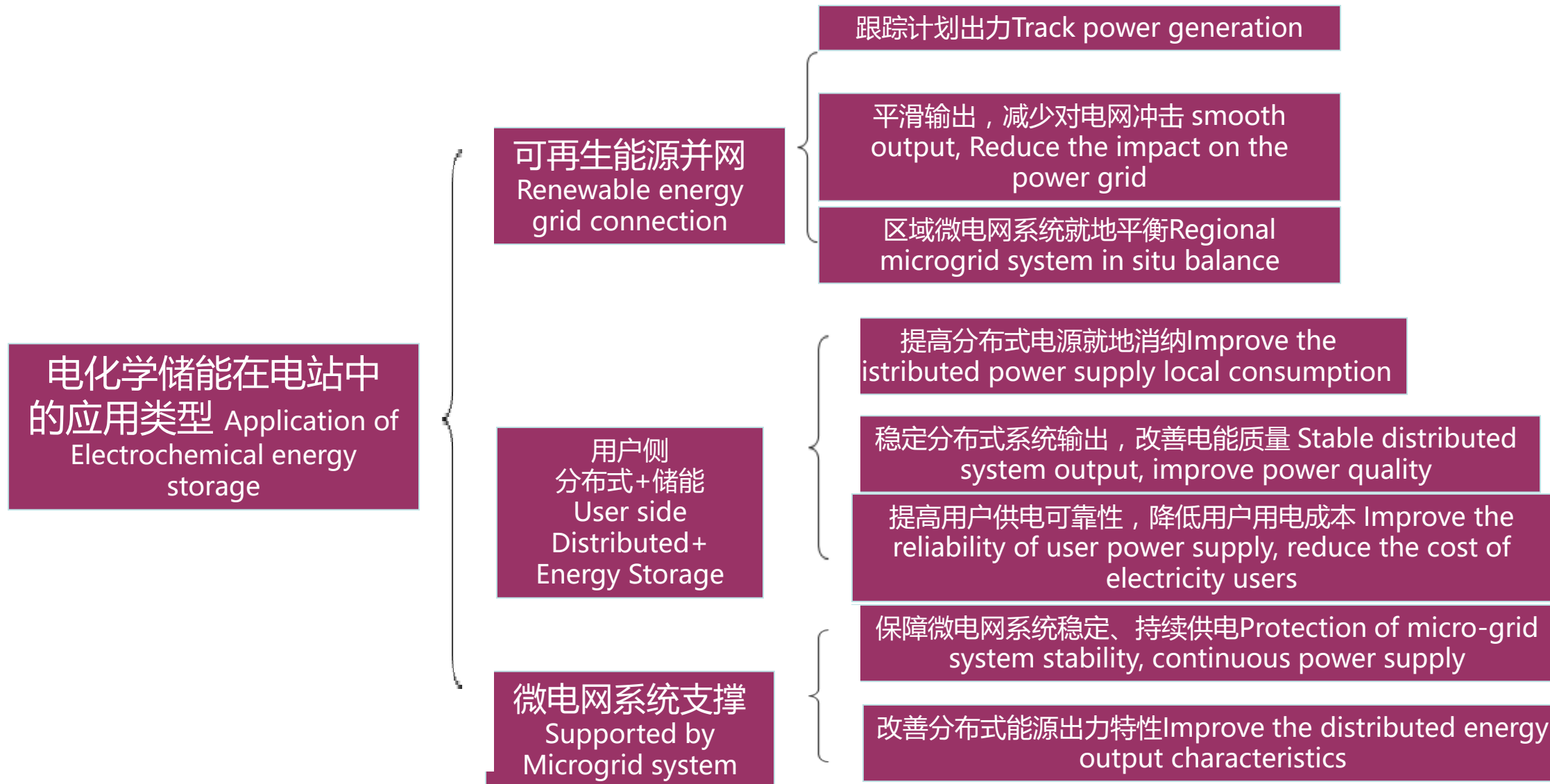

储能技术 Energy storage tech.	铅炭电池 lead carbon battery	磷酸铁锂电池 Li-iron phosphate battery	三元电池ternary battery	钠硫电池 Sodium sulfur battery	全钒液流电池 Vanadium redox battery
成本 Cost (元 / kwh)	950~1200	2000~2350	2600	3000~4000	3500
放电深度 (DOD%)	60%~70%	90%	95%	接近 approx. 100%	100%
循环寿命 life cycle (次 times)	3600~4200	≥4500	6000~ 10000	2500~ 4000	12000
充放电效率 Eff. Of charge & discharge	81%	85%	92%	95%	75%
系统优势 System advantage	技术成熟度较高，价格较低，稳定性好 mature tech., lower cost, more stable	能量密度、功率密度较高，安全性好 Higher Energy density & power density, safer	能量密度、功率密度高，系统效率有继续开发空间 Higher Energy density & power density, system eff. to be better		使用寿命长，转换效率高 Long service life and high conversion efficiency
系统劣势 System disadvantage	充放电速率慢，能量密度低、整体效率偏低 low Charge & discharge rate, low energy density, low overall efficiency	目前价格偏高，能量密度达到瓶颈 current price high, there is bottleneck of the energy density	安全性能待验证 security to be verified	当前国内技术不成熟 currently tech not mature in China	能量密度低，使用环境要求高 Low energy density, high requirements on environment

- **大型地面电站配套储能系统 Energy storage system for large scale power plant**
  - 1 ) **组建分布式电源+储能区域型微电网系统，促进分布式电源与负荷的就地平衡，减少对系统容量需求；** Distributed power supply + energy storage microgrid system to promote the balance of distributed power and load, and reduce the system capacity requirements
  - 2 ) **通过配置一定容量的储能系统，可以在电网输送通道受限情况下，将多余光伏发电储存在储能系统中，在合适的时间再返送电网。** Through the allocation of a certain capacity of the energy storage system, the excess PV power can be stored in the case that the grid transmission channel is limited, and returned to the grid at proper time
  - 3 ) **在新能源发电厂内配置一定量的储能系统，可以优化新能源厂站出力曲线，提高电能质量、减少对系统的冲击；** Install a certain amount of energy storage system in the renewable energy power plant, and the plant output curve can be optimized, power quality can be improved, and the impact can be reduced to the system.



### 巴基斯坦100MW光伏储能项目—平滑输出减少对电网冲击

100MW PV Storage Project in Pakistan - Smooth Output Reduces Impact onto Power Grid

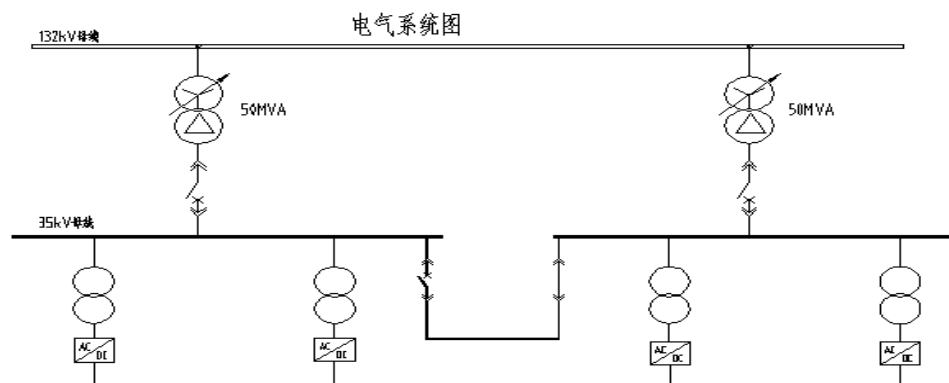

50MW光伏系统

25MW/60MWh储能系统

50MW光伏系统

25MW/60MWh储能系统



- **系统组成**：100MW光伏系统 + 50MW储能系统（配置120MWh磷酸铁锂电池） System: 100MW PV + 50MW energy storage system (120MWh Li-iron phosphate battery)
- **作用**：储能系统的应用使光伏系统变为稳定出力系统，同时储能系统通过快速调节能力必要时可以起到电网的支撑作用，大大缓解了当地电网的供电压力，提高当地电网的稳定性。 Function: energy storage system makes the PV system a stable output system, and it provides support to the grid by fast adjustment when necessary, which greatly eases local pressure of the grid and improves the stability.
- **难点**:通过对电网结构及负荷平衡需求，合理配置储能单元容量。 Difficulty: allocates the energy storage unit capacity by the balance needs of grid and load

### 二连浩特可再生能源微电网示范项目—负荷就地平衡 Renewable energy microgrid demonstration project - local load balance (Er Lian Hao Te)

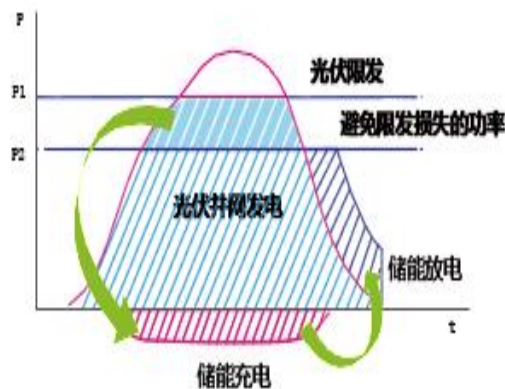
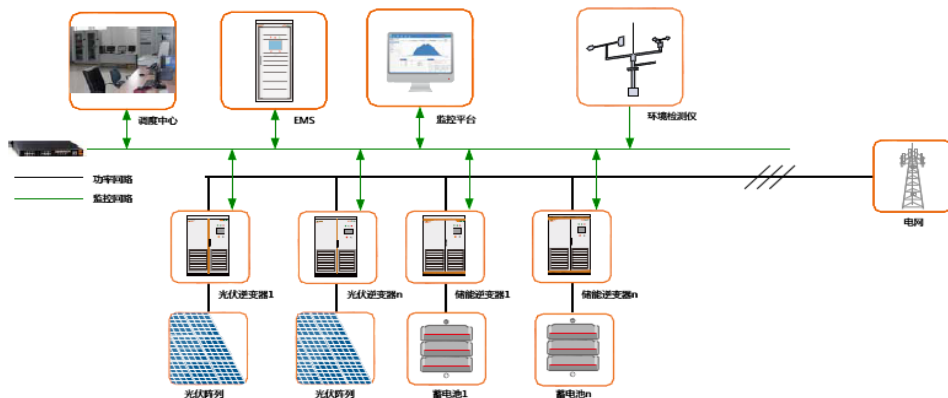

- 系统组成：370MW风电系统+50MW光伏系统+50MW光热系统+24MW固体砖蓄热系统+10MW储能系统（配置80MWh全矾液流电池）** System: 370MW wind + 50MW PV + 50MW CSP + 24MW solid brick thermal storage system + 10MW energy storage system (80MWh redox flow battery)
- 作用：通过储能系统快速充放电特性，满足区域微电网系统新能源出力与负荷的平衡，同时区域微电网系统与电网相连，满足系统调峰需求。** Function: Through the fast charge and discharge in energy storage system, the balance of new energy output and load of the regional microgrid can be met, while the regional micro-grid system is connected to the grid to meet the system peak load.

**■ 分布式电源+储能系统 Distributed power supply + energy storage system**

1 ) 随着分布式光伏统筹上网电价逐年下降以及储能系统成本降低，建设分布式+储能系统实现分布式电源全部就地消纳具有较好的经济效益，同时利用储能系统每天“两充两放”的特性，合理利用阶梯电价，提高系统效益。 With the distributed PV grid prices and the energy storage system cost decreasing every year, there is good economic benefit to build the distributed + energy storage system to achieve all the local power consumption, and because the energy storage system charges and discharges twice every day, the step tariff, if well employed, can increase the system benefit.

2 ) 通过能量管理系统控制分布式电源+储能系统平滑输出，减小外部气象条件对分布式电源输出的影响，提高供电电能质量。 Achieving smooth output from the distributed power supply + energy storage system by the energy management system, reducing the impact to the distributed power output from the external weather conditions and improving the quality of power supply.

3 ) 通过分布式电源+储能系统组成并网型微电网系统，当电网故障时，自动切换至独立运行模式，保持重要负荷连续供电/或者利用储能系统代替企业原有设计起到后备电源（UPS）的作用。 When the grid breaks down, the microgrid system that is composed of the distributed power supply + energy storage system automatically switches to stand-alone mode, which maintains continuous power supply or uses energy storage system to replace the UPS in the original design.

## 光储柴智能微电网示范 PV-Diesel-BESS microgrid system

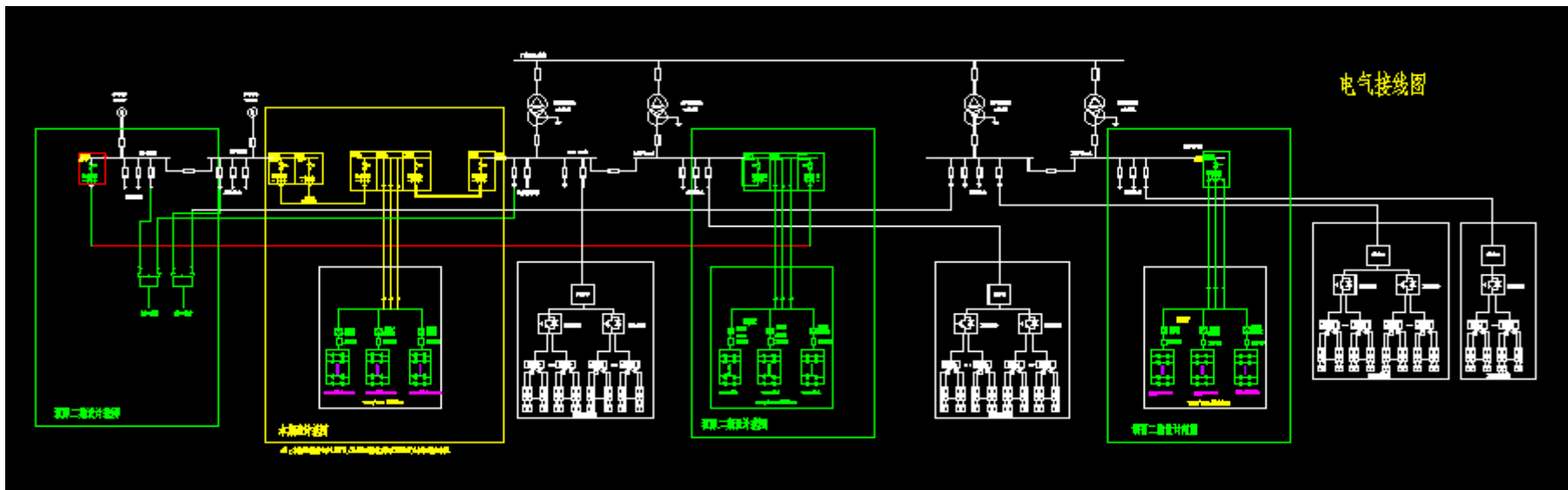

- 系统组成：3MW光伏系统+3个1.5MW/3MWh的储能系统+柴油发电机组  
System: 3MW PV system + 3 1.5MW / 3MWh energy storage system + diesel generator set
- 储能系统作用：按照每天“两充两放”的模式设计，在夜间低谷电价充电，峰值电价放电，同时配合光伏发电系统在光伏出力高峰期/电价波平阶段按一定功率充电，在波峰阶段放电；储能系统可以代替企业UPS保障精密机房设备连续供电。 Function of energy storage system: by the daily "two charge and two put" design, charge during night when the price is at the lowest and discharge at peak time; Energy storage system supply continuous electricity and replace UPS.

### 北京汉能清洁能源中心光储联网示范项目 Beijing Hanneng renewable



- **系统组成：321kW光伏系统+500kWh锂电池储能系统 System: 321kW PV system + 500kWh Li battery energy storage system**
- **储能系统作用：分布式电源及储能系统在0.38kV母线汇集后，可通过快速开关与大电网联网运行，也可切换为离网运行状态，用于当电网故障时，自动切换至独立运行模式，保持重要负荷连续供电。 Function of energy storage system: distributed power supply and energy storage system join on the 0.38kV bus, and they can be connected to grid via fast switching device, and can also be switched to off-grid status, when grid breaks down, it automatically switches to stand-alone mode, to maintain continuous power supply to key load**

- **交流母线的储能微网系统 Energy storage microgrid system for AC bus**

**特点：分布式发电单元配置逆变器、储能单元配置储能逆变器PCS，各个单元在交流母线侧汇集，统一向负荷供电的系统。 Features: the inverter for the distributed power block, the inverter PCS for the energy storage unit, and all units joining on the AC bus side, supplying power to the l**

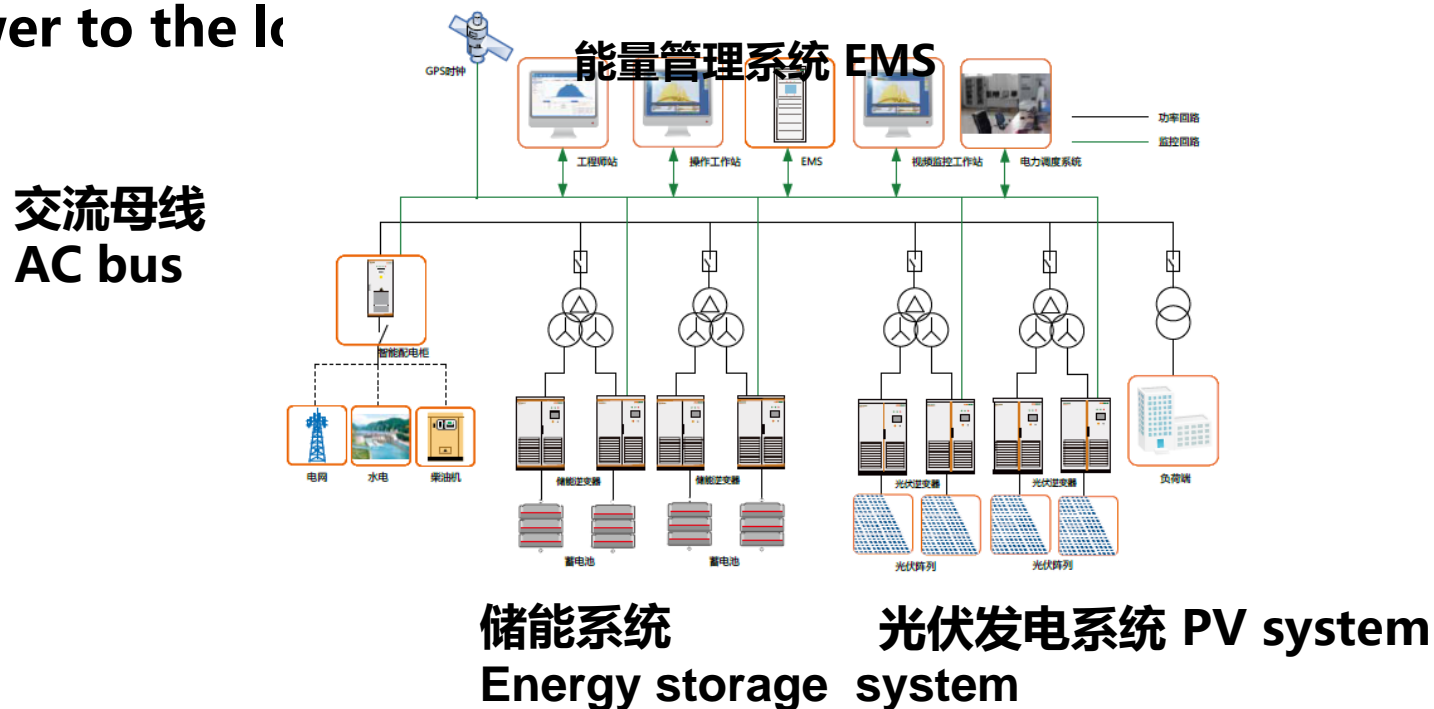

## 交流母线接线设计案例--西藏措勤县风光柴储微网示范项目 Design of AC Busbar Connection - Case Study, Qicheng County, Tibet

海拔高度Altitude 4800m



- **多能互补：441kW光伏发电系统+60kW风力机组+1.2MWh铅酸蓄电池组+300kWh锂电池组+1台备用柴油发电机** Various-energy combination: 441kW PV+ 60kW wind + 1.2MWh lead-acid battery pack + 300kWh lithium battery pack + 1 standby diesel generator
- **分布式电源及储能系统采用0.38kV母线汇集，再升压至10kV，与措勤县水电站并网运行，提高供电可靠性，并可在枯水期离网运行，保障措勤县重要负荷的供电** Distributed power supply and energy storage system using 0.38kV bus collection, and then increasing to 10kV, connect to the hydropower grid in Cuoqin County, which improves the reliability of power supply, and runs in the dry season off-grid to ensure the power supply to important loads in CuoQin county.

交流母线接线设计案例--青海省玉树州治多县光储微网示范电站 海拔高度4200m  
AC bus wiring design case - Yushu County, Qinghai Province, Zhiduo County,  
light storage network demonstration power station, altitude: 4200m



- **2.4MW光伏发电系统+14.4MWh铅酸蓄电池组 2.4MW PV + 14.4MWh lead acid battery**
- **光伏发电系统与储能系统采用10kV母线汇集后，统一输出与当地水电站的并网运行，提高供电可靠性，并可在枯水期离网运行，保障治多县重要负荷的供电。 PV system and energy storage system joining on 10kV bus, connect to local hydro-grid, which improves the reliability of power supply, and enables the system to operate during the dry season, ensuring the power supply to the important loads in multiple counties.**



## 混合母线的储能微网系统 Energy storage microgrid system of mixed bus

特点：储能单元通过控制器与分布式单元在直流侧并网，再统一由逆变器输出交流电源向负荷供电的系统。 Features: The energy storage unit connects to the distributed unit via controller on the DC side of the grid, and then supply AC output to the loads via inverter.

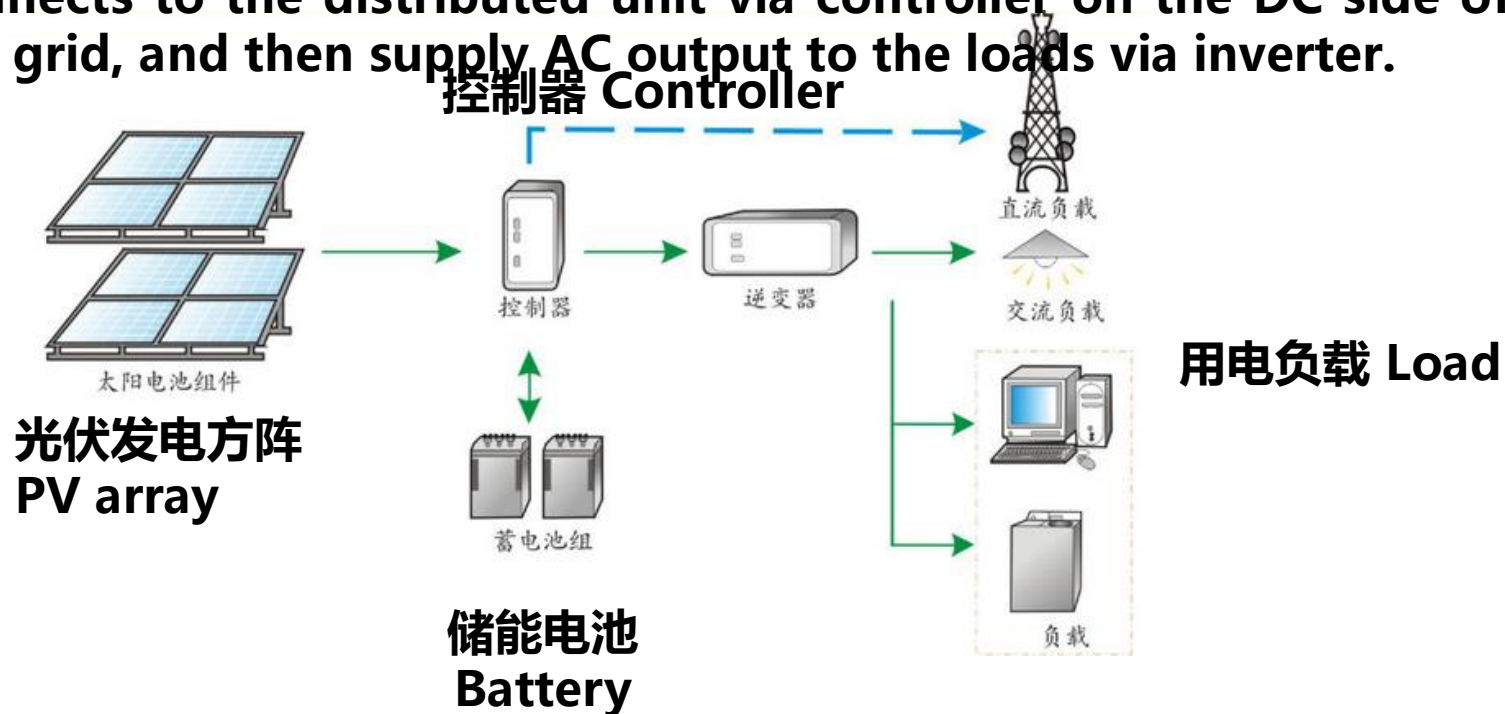

## 3

**光储微网系统及案例 Energy Storage  
Microgrid Connected System & Case**

**混合母线接线设计案例--青海省玉树州水光互补微网发电示范项目 Mixed bus  
wiring design case - Qinghai Yushu aqua-solar microgrid  
demonstration project  
海拔 Altitude 3980m**



- **2MW光伏电站+15.2MWh蓄电池组 2MW PV+ 15.2MWh battery pack**
- **光伏发电通过充电控制器在直流侧对蓄电池进行充电，光伏和蓄电池组统一升压至35kV后接入玉称电网和当地水电站互补运行。 PV charges battery on the DC side via charger controller, PV as well as the battery pack boost to 35kV and connect to grid and local hydropower plant.**
- **本电站能为玉树地区提供3.8小时稳定的2MW电力供应，对缓解当地电网供电压力以及确保电网稳定运行起到重要作用。 The plant can provide stable electricity of 2MW for 3.8 hours, playing an important role in relieving local pressure of power supply and stabilizing the grid operation.**

## 3

## 光储微网系统及案例 Energy Storage Microgrid Connected System & Case

混合母线接线设计案例--河北电力科技园光储热一体化示范工程 Mixed bus wiring design case - Integration of Solar and Thermal Storage project, Hebei Electric Power Science and Technology Park

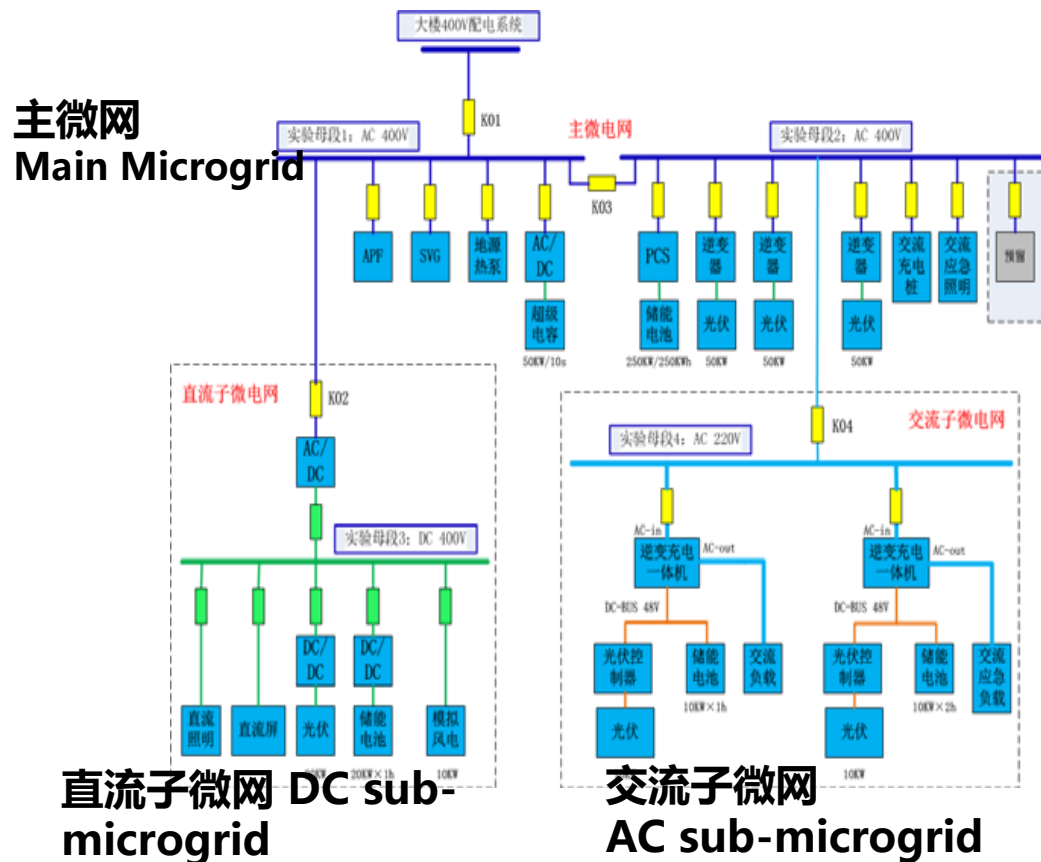

- (1) 150kW 光伏发电单元 PV power block
- (2) 250kWh 储能单元 storage unit
- (3) 50kW×10s 的超级电容 Supercapacitor
- (4) 地源热泵系统 geo-thermal pump system
- 建设光伏发电、储能、地源热泵一体化微电网，实现绿色园区可再生能源的综合利用。 Construction of PV, energy storage and geo-thermal pump microgrid, achieve comprehensive utilization of renewable energy.

## 3

## 光储微网系统及案例 Energy Storage Microgrid Connected System & Case

**混合母线设计案例--西藏自治区自然科学博物馆兆瓦级光伏储能示范电站**  
**Mixed bus wiring design case - Megawatt-class PV storage demonstration power plant in the Natural Science Museum, Tibet**



- **1MW光伏+1MWh蓄电池组 1MW PV + 1MWh battery pack**
- **800kW光伏接入博物馆低压母线，200kW光伏和蓄电池组以及自同步电压源逆变器组成自同步发电系统。市电情况下直接并网，无电情况下组建博物馆内部的微型电网为博物馆负荷提供电源。 800kW PV access to the museum low-voltage bus, 200kW PV and battery as well as self-synchronous voltage source inverter constructs the self-synchronous power generation system, directly connecting to the municipal grid, and provide power to the museum loads in the museum in the case of off-grid.**
- **本工程改善了博物馆电力能源结构的合理性，对博物馆小电网形成有效补充，而微电网的建设在一定程度上缓解电力供应紧张的局面。 This project improves the rationality of the electric power structure of the museum, provides effective supplement to the small grid of the museum, and the micro-grid ease the power supply situation to a certain extent**

**➤ 电储热及案例 Electrical thermal storage**

电储热系统采用熔盐储能技术，应用于供暖方面，熔盐储能利用弃风弃光的电能或夜间的低谷电，通过熔盐加热器将低温熔盐加热成高温熔盐，高温熔盐将热量传递给循环热水，从而产生水蒸气，进行供暖。在供热过程中避免了传统锅炉供暖模式，降低了环境污染及取暖成本。 Electrical thermal storage system uses molten salt storage technology, applied in heat supply. Molten salt storage uses the abandoned wind and solar energy, by heating up the low-temp salt to high-temp salt via molten salt heater. The high-temp salt passes heat to the circulating hot water and generates steam. This process avoids traditional boiler and reduces pollution and the heating cost.

**电储热案例 中投亿星辛集熔盐储能绿色供暖项目**

Case: Electrical thermal storage, molten salt heating project, ZhongTou YiXing

### ➤ 电储热及案例 Electrical storage and case

电储热系统采用固体储热技术，应用于供暖方面，在预设的电网低谷调峰时段或风力发电的弃风电时段，自动控制系统接通高压开关，高压电网为高压电发热体供电，高压电发热体将电能转化为热能，同时被高温蓄热体不断吸收，当高温蓄热体的温度达到设定的上限温度或电网低谷时段结束或风力发电弃风电时段结束时，自动控制系统切断高压开关，高压电网停止供电，高压电发热体停止工作。高温蓄热体通过热输出控制器与高温热交换器连接，通过调节变频风机的频率，高温热交换器将高温蓄热体储存的热能在24小时连续均匀地释放到热网循环水中。同时通过快放功能，可放热，以适应极端天气温度下的热网调节。 The thermal storage system adopts solid heat storage technology, which is used in heat supply. In the preset grid peak adjusting period or the wind power generation period, the automatic control system is connected with high-volt switch, the high voltage grid supplies the high voltage heater, The high-voltage heating element converts the electrical energy into thermal energy and is continuously absorbed by the high-temp heat accumulator. When the temperature of the high-temp heat accumulator reaches the upper limit of the set temperature or the grid trough ends or the period of abandoned wind power ends, the automatic control system cuts off the high-volt switch, high-voltage grid stops the power supply, and the high-voltage heating element stops working. The high-temp heating accumulator connects the high-temp heat exchanger via the heat-output controller, by adjusting the frequency of the variable-frequency blower, the high-temp heat exchanger releases the heat stored in the high-temp accumulator into the circulating water continuously within 24 hours. In addition, it has a fast release function to meet the demand of the heat supply network under the extreme weather conditions.

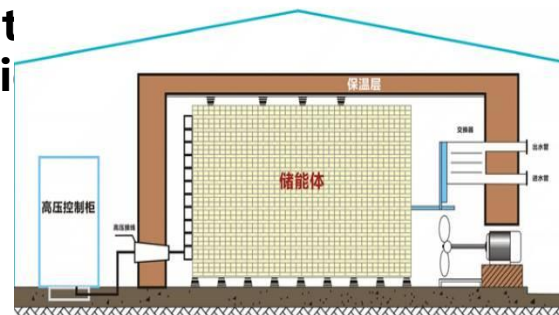

### ➤ 压缩空气储能 Energy storage of Compressed air

压缩空气储能技术主要应用于发电方面，压缩空气储能是基于燃气轮机技术提出的一种能量存储系统。在储能时，压缩空气储能系统耗用电能将空气压缩并存于储气室中；在释能时，高压空气从储气室释放，进入燃烧室利用燃料燃烧加热升温后，驱动透平发电。由于储能、释能分时工作，在释能过程中，并没有压缩机消耗透平的输出功，因此，相比于消耗同样燃料的燃气轮机系统，压缩空气储能系统可以多产生2倍甚至更多的电力。压缩空气储能具有适用于大型系统（100 MW级以上）、储能周期不受限制、系统成本低、寿命长等优点；但存在对大型储气室、化石燃料的依赖等问题。 Compressed air energy storage technology is mainly used in electricity generation, compressed air storage is an energy storage system based on gas turbine technology. During the energy storage, the compressed air energy storage system compresses air and stores it in gas chamber using electricity. When releasing the energy, the air of high pressure is released from the gas storage chamber and enters the combustion chamber getting heated up by the fuel combustion. Because there is no power consumed by the compressor, the compressed air energy storage generates 2 times or more electricity than the gas turbine system. Therefore, compressed air energy storage is applicable to large system (100MW or above), unlimited storage cycle, low system cost and long life. However, for big air storage rooms and fossil fuels.

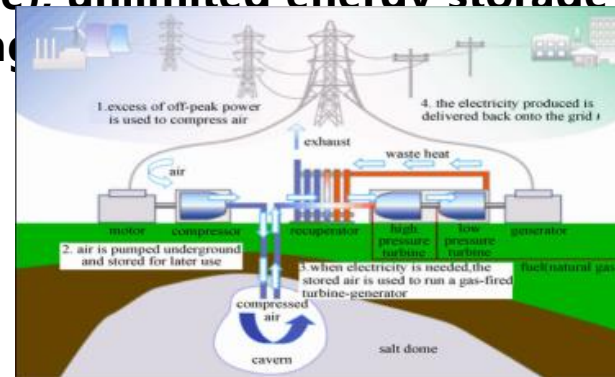
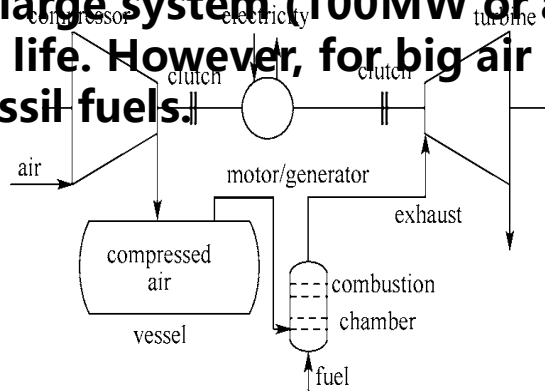

- 某市经济开发区冷热电三联产分布式能源站项目 CCHP distributed energy plant in city economic development zone



- 1×6.63MW 燃气轮发电机组+1×15t/h 余热锅炉+1×15t/h 天然气燃气锅炉 1×6.63MW Gas Turbine Generator units+ 1 × 15t / h Waste Heat Boiler + 1 × 15t / h Natural Gas Boiler
- 本工程给松滋市城东工业园提供了15t/h ( 1.6MPa、201℃ ) 工业用汽负荷和6.63MW的用电负荷。This project provides 15t / h (1.6MPa, 201 °C) industrial steam load and 6.63MW electricity load to Songzi Chengdong Industrial Park.
- 能源站不仅满足了企业热负荷的需要，还降低了蒸汽成本，同时还减少了污染物的排放。Power stations not only meet the needs of the enterprise heat load, but also reduce the steam cost as well as the emissions of pollutants.



## 结语

- 以上是我们从事光伏电站设计工作中的一些设计经验总结，观点不妥之处，恳请各位专家、同行批评指正。  
Above is the summary of our experience in the PV plant design work, please point anything out that may need further discussion.
- 我们也同样期盼着能与各位业内同行有更深的交流和合作机会，谢谢！  
We are also looking forward to the cooperation and knowhow exchange with you, thank you!



**河北能源工程设计有限公司**

HeBei Energy Engineering Design Co., Ltd.