



LONGI

A model to evaluate the self-shading effect by bifacial system

Dr. Brain Zhu · Wei Hai
PVPMC CHINA
Nov. 2018

www.longigroup.com

目录

CONTENTS

1

Bifacial products in Longi

2

Bifacial energy yield gain in different regions

3

Self-shading models

4

Conclusion

Product in Longi

- Longi is a company with mono wafer, cell, module and Plants. More combined technology is considered.
- Bifacial product is the preferred system solution by Longi to produce more clean energy.

LONGI



The efficiency roadmap for bifacial PERC cells

- The efficiency of bifacial cells could be improved by 0.1%~0.2% per half year.
- The mass production efficiency has reached about 22%
- The bifaciality is more than 75%

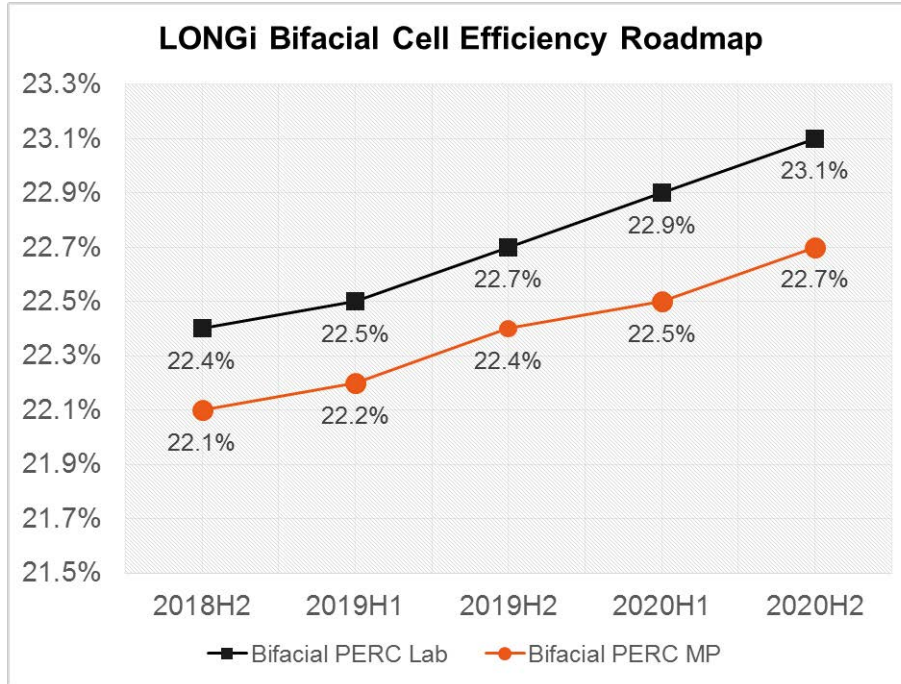

Bifacial cell efficiency record

Front efficiency	23.11%	
Rear efficiency	18.97%	
bifaciality	82.09%	

(2018.8)

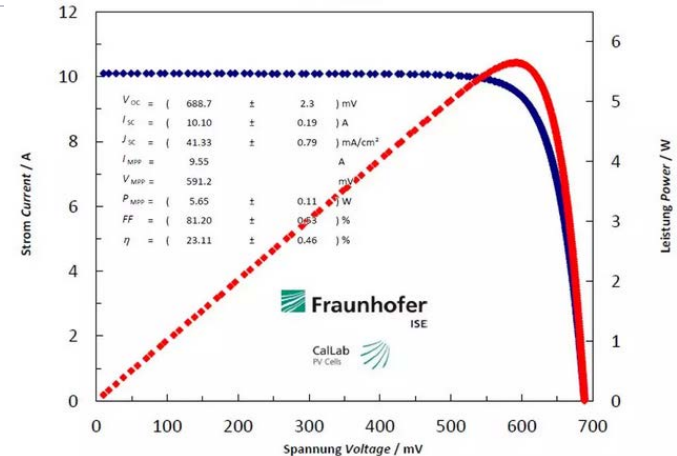

目录



Bifacial products in Longi



Bifacial energy yield gain in different regions



Self-shading models



Conclusion



Bifacial energy yield gain in different regions

- The bifacial system have different energy yield gain in different region

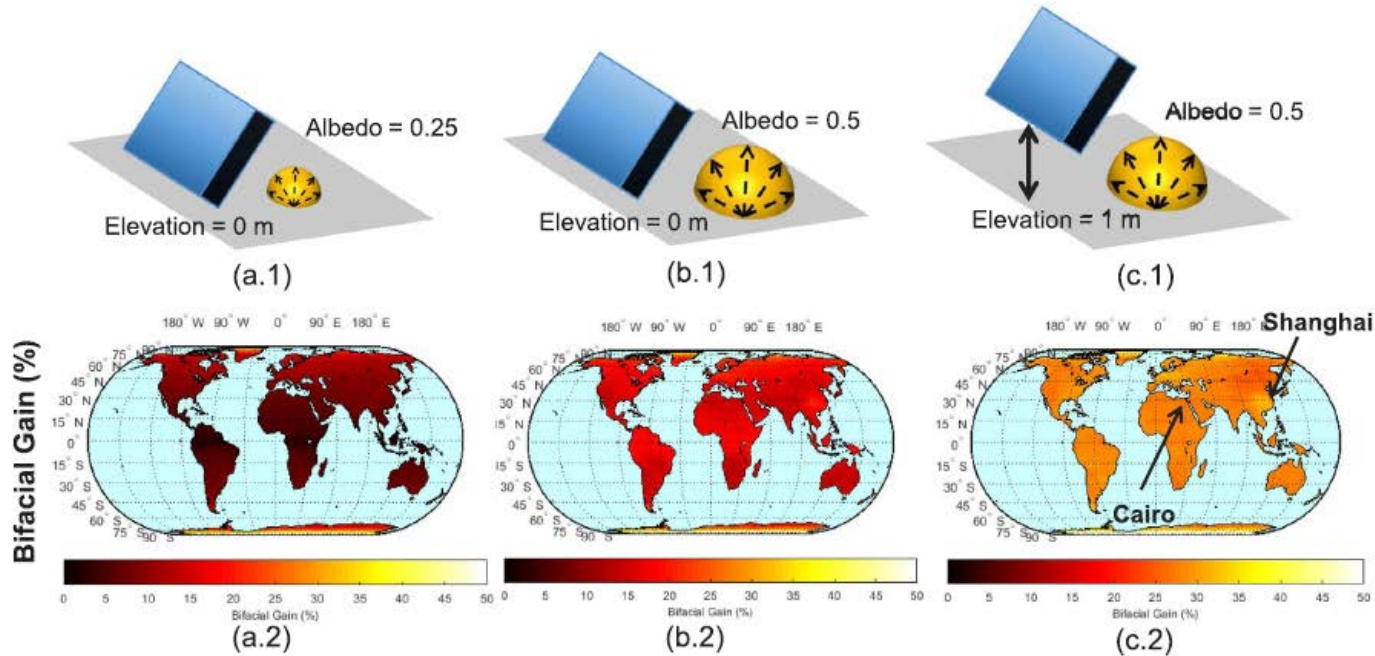

[1] X. S. Sun, et al., Applied Energy, 212(2018), 1601-1610

Longi global demonstration system

- In order to evaluate the region difference of bifacial energy yield gain, Longi set up the global demonstration system.

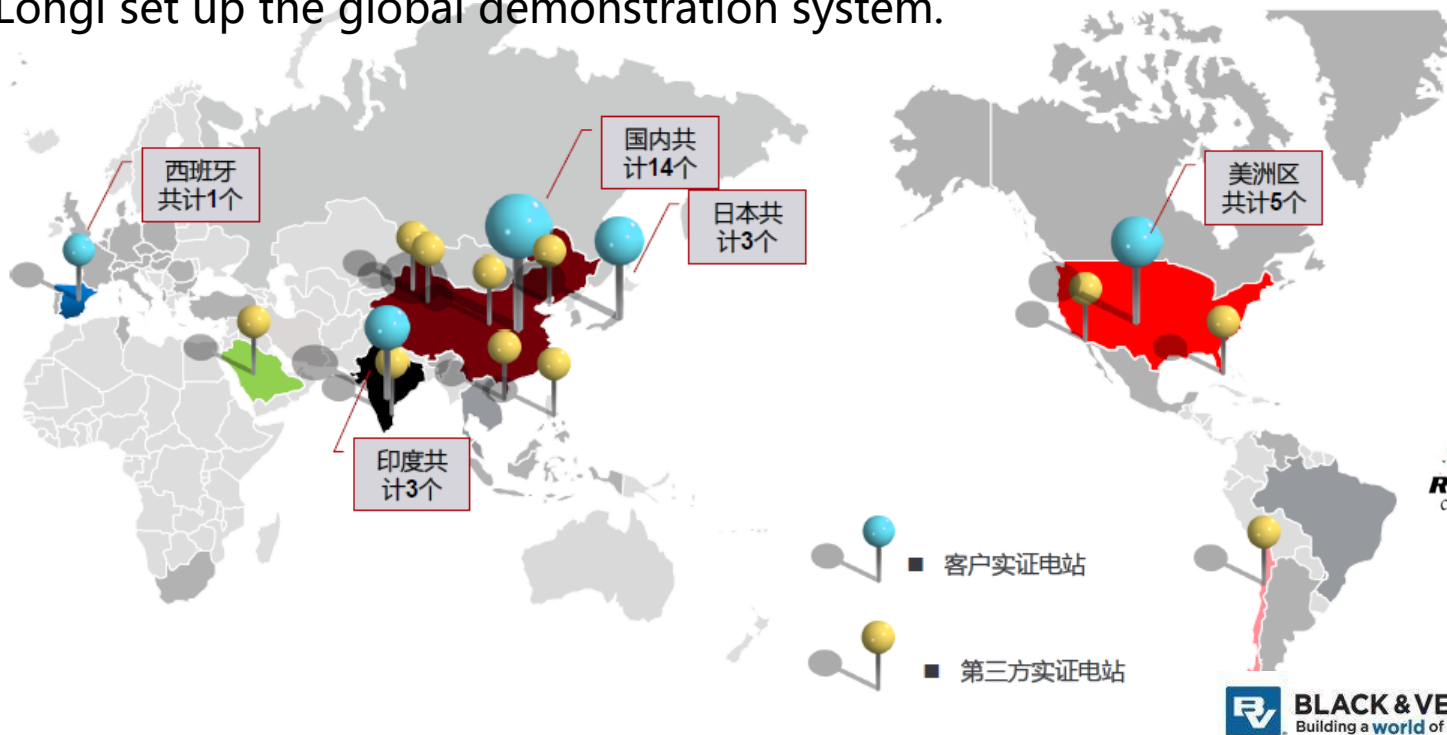

Precisely Right.



Bifacial system — installation height

- The demo system shows that, if the installation height for bifacial modules with high reflectance ground is increased to 2m, the energy yield gain could reach 19.75%.

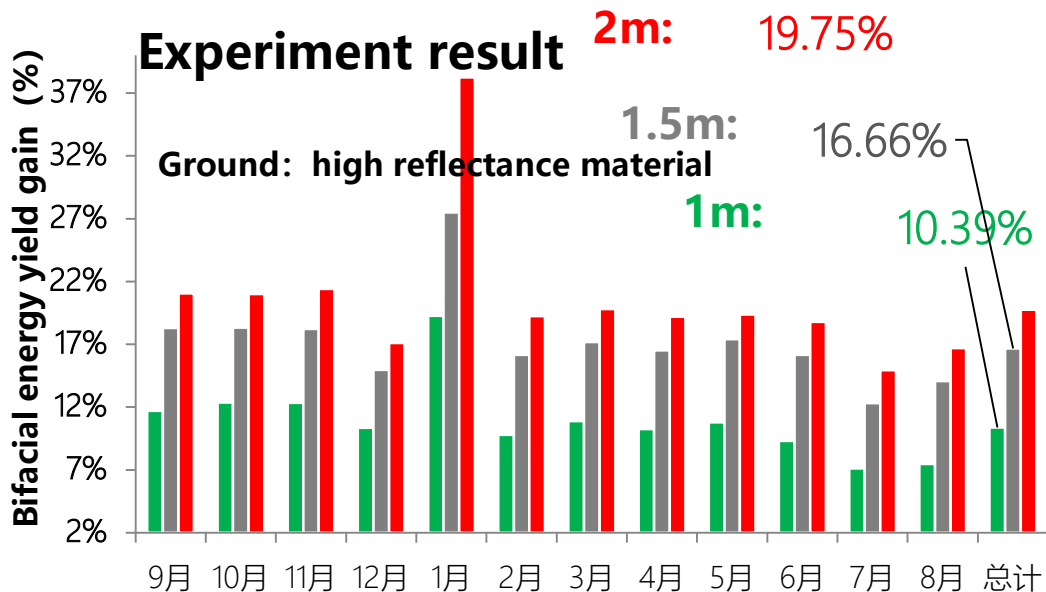

Bifacial system — installation height

- The studies by NREL shows that the bifacial energy yield gain on the sand ground grows slowly when installation height is above 1m.
- Sun et al. shows that the installation height of bifacial system differs from ground reflectance and latitude.

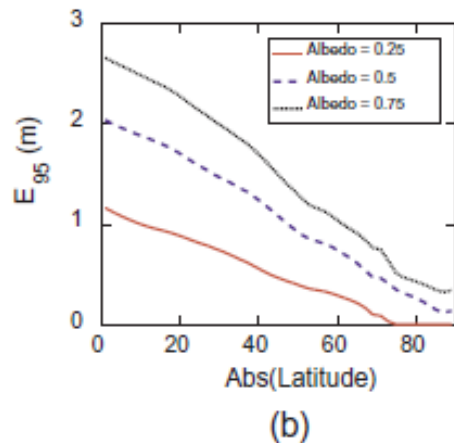
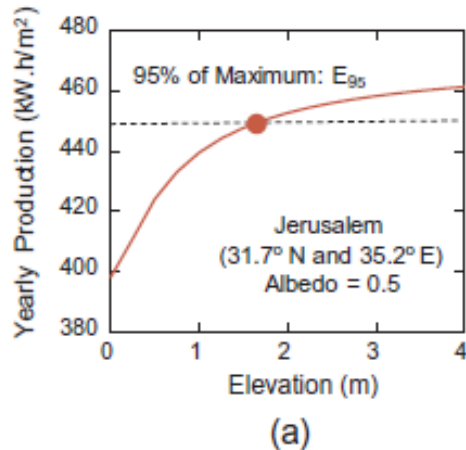

[1]Chris Deline, et.al., Evaluation and Field Assessment of Bifacial Photovoltaic Module Power Rating Methodologies, 2016

[2]J. Libal et al., bifi-PV workshop 2017

[3] X. S. Sun, et al., Applied Energy, 212(2018), 1601-1610

Bifacial system — ground reflectance

1. The energy yield gain of bifacial system increases as the ground reflectance increasing.



A. Grass (+4.9%)

B. Concrete (+8.19%)

C. High reflectance material (+10.58%)

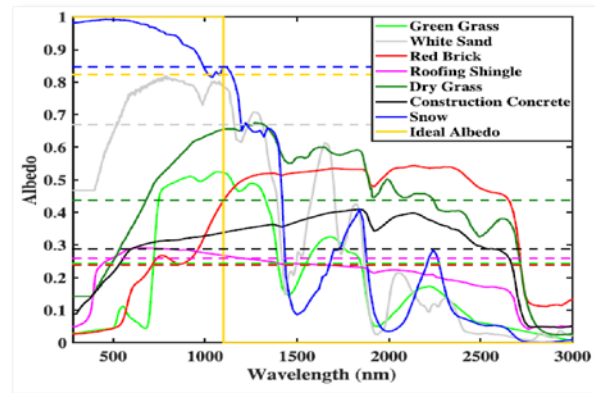

The reflectance for different ground

Ps: Taizhou in Jiangsu, 20° tilted system, 1m height, baseline: mono PERC, 1year data

[1]Russell, Thomas C. R., et al. "The Influence of Spectral Albedo on Bifacial Solar Cells: A Theoretical and Experimental Study."



Bifacial system — Low working temperature

- The data from TÜV Rheinland system shows that the working temperature of bifacial system is about 1-2 °C lower than single face module.
- The IR wavelength light transmission is higher for bifacial modules without BSF

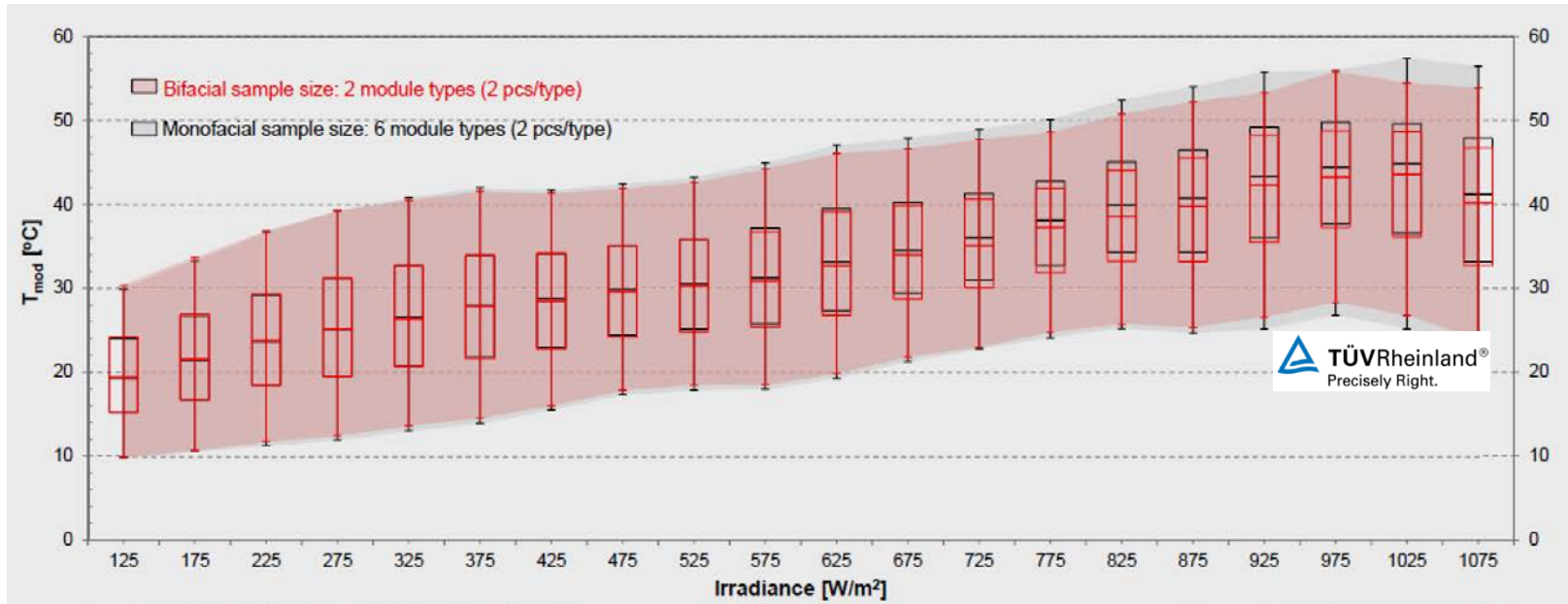

* Field data were collected in Cologne, Germany from August 2017 to October 2017

Longi demo system—Taizhou

■ Demo system in Taizhou: (compared to poly system)

- Concrete ground, bifacial gain: 11%
- TPO 2m installation height, bifacial gain: 23.7%
- The difference between PV System simulation result and experiment result is only about 2% (Pv system little lower)

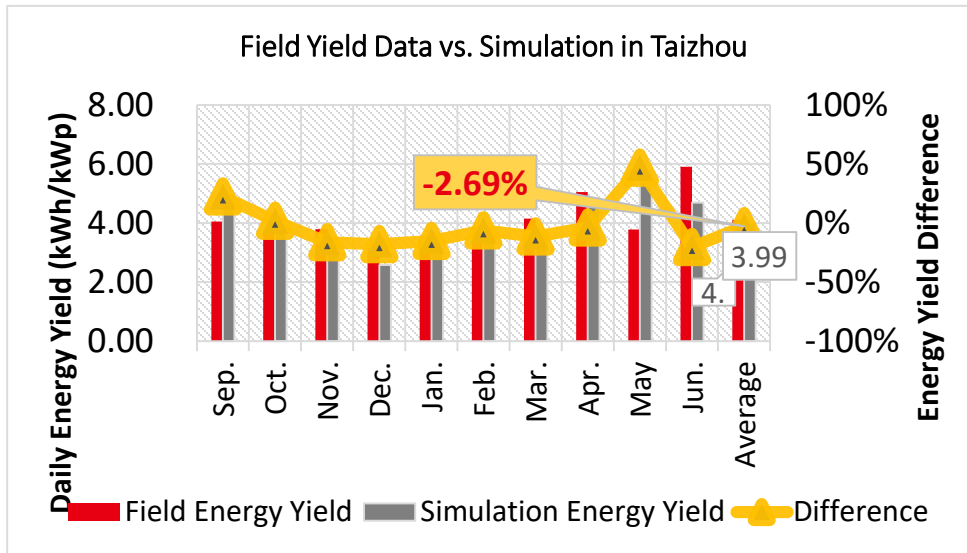
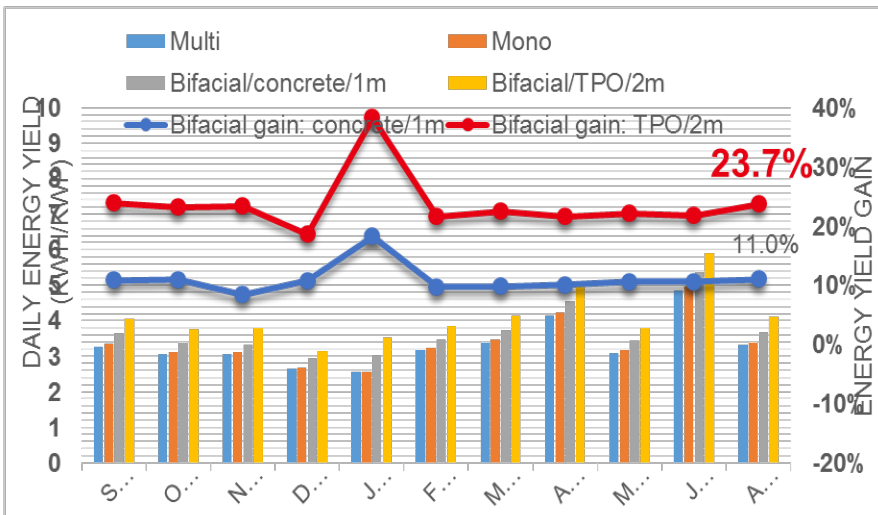

Longi demo system—Qing hai

- Demo system in Qinhai: (compared to poly system)
- One axis tracking system, bifacial gain: 19.27%
- The difference between PV System simulation result and experiment result is only about 1.13% (PV system little lower)



Field Yield Data vs. Simulation in Qinghai

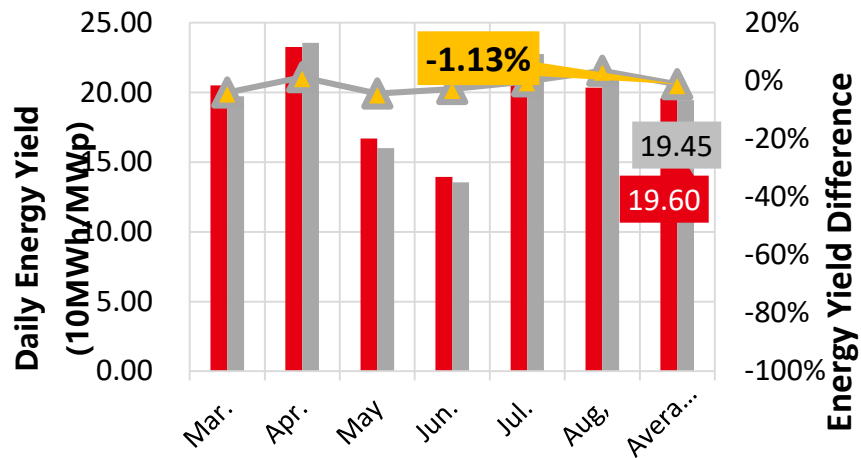
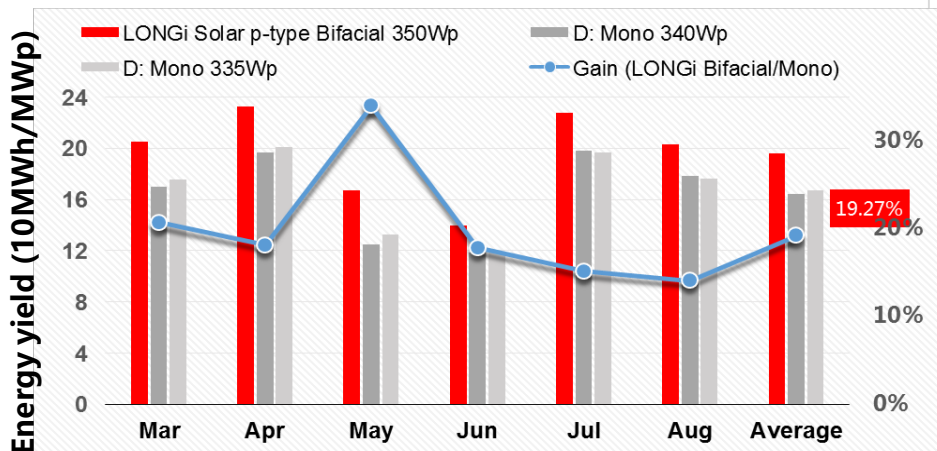

Longi demo system—Turpan

1. Bifacial gain: 23% (62days, compared to PERC)
2. The bifacial energy yield gain is related to backside irradiation.

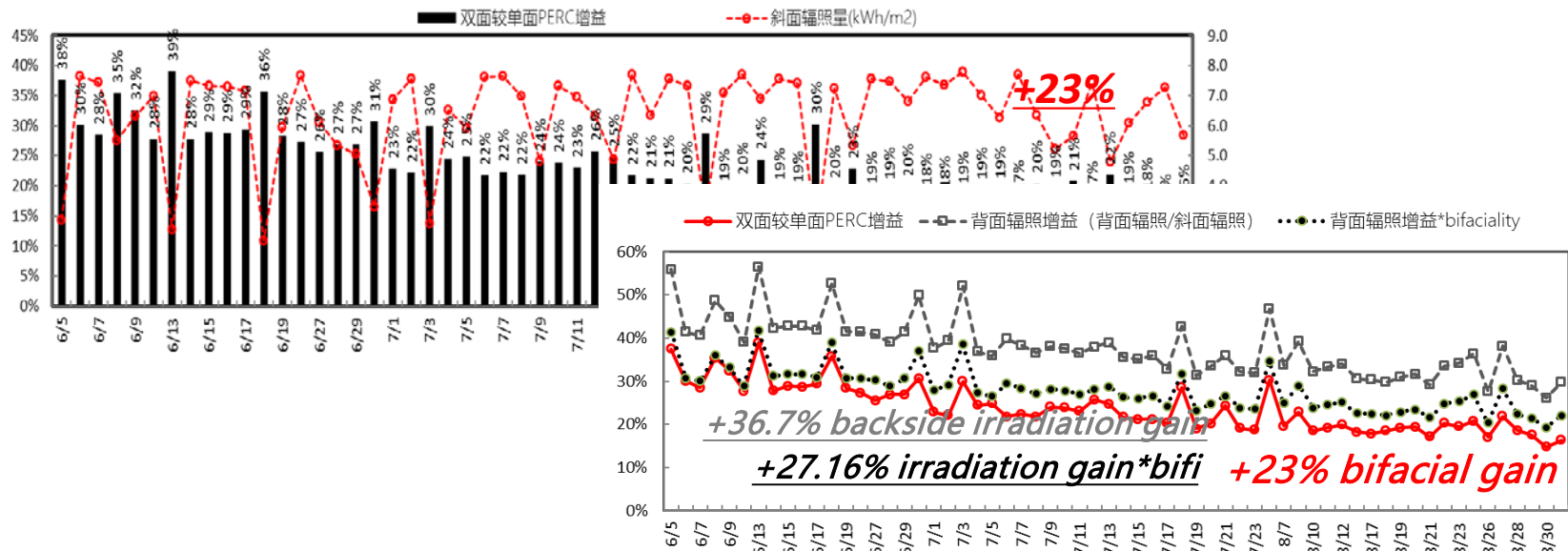

Longi demo system—Hainan Waining

1. Bifacial gain: 22.4% (21 days, compared to PERC, white paint ground)

2. The bifacial energy yield gain is related to backside irradiation.

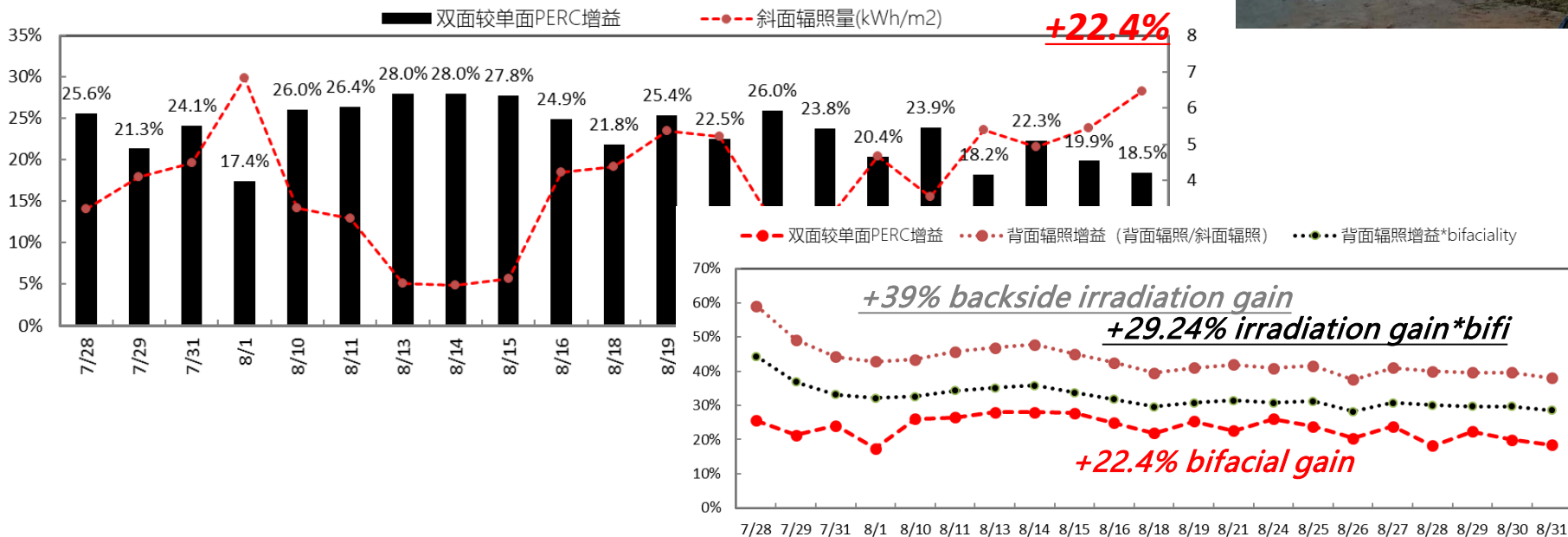

目录



Bifacial products in Longi



Bifacial energy yield gain in different regions



Self-shading models



Conclusion

- The data by Bo Yu shown that the energy yield gain of the N-type bifacial modules on grass ground is only about 3.21%
- In some season, it is only about 1.19%.^[1]
- **Is this the ability of bifacial modules on grass ground?**



Table 2
Energy output measurement in year 2014.

Month	Bifacial modules (kW h/kWp)	Regular modules (kW h/kWp)	Relative difference of energy output (%)
1	65.33	62.07	5.00
2	81.58	78.07	4.30
3	77.68	75.96	2.21
4	107.75	105.05	2.51
5	106.67	102.39	4.01
6	109.96	105.86	3.73
7	88.77	84.77	4.51
8	107.93	104.60	3.09
9	107.72	105.47	2.08
10	75.02	73.86	1.54
11	79.72	78.77	1.19
12	60.42	57.79	4.36
Average	89.05	86.22	3.21

Self-shading models

- While the data by Y. K. Chieng^[1] and X. S. Sun^[2] shows the yield gain is more than 10%.
- Even though the reflectance of grass differs from types, the energy yield gain of bifacial modules on grass could be more.

Location (Type)	Elevation/module height (m)
Cairo (Sim.) [11]	1/0.93
Cairo (Sim.) [11]	1/0.93
Oslo (Sim.) [11]	0.5/0.93
Oslo (Sim.) [11]	0.5/0.93
Hokkaido* (Exp.) [45]	0.5/1.66
Hokkaido* (Exp.) [45]	0.5/1.66
Albuquerque (Exp.) [16]	1.08/0.984
Albuquerque (Exp.) [16]	1.08/0.984
Albuquerque (Exp.) [16]	1.03/0.984
Albuquerque*** (Exp.) [16]	0.89/0.984
Golden (Exp.)****	1.02/1.02

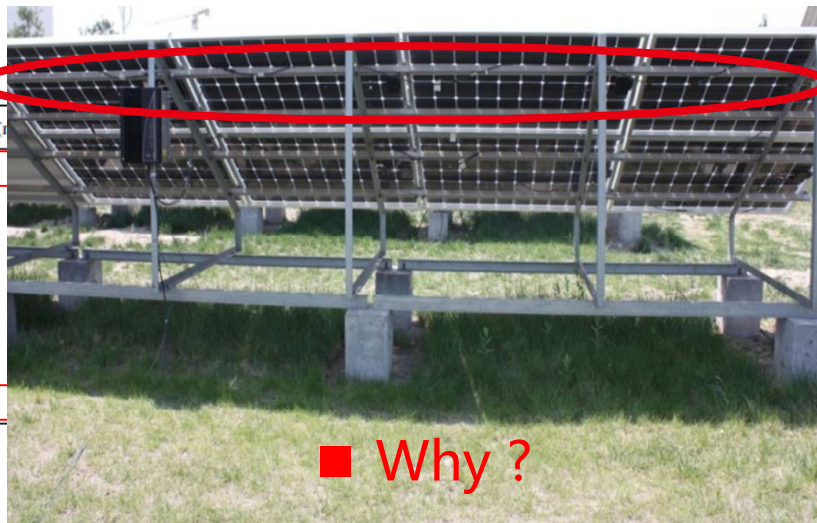

Table I. Measured output of simulated bifacial module

condition	Background	I_{front} (A)	I_{back} (A)	I_{back}/I_{front} (%)
clear day	Grass field	1.17	0.17	15
	White wall	1.16	0.24	21
	Beach, on sand	1.15	0.25	22
partly cloudy day	Grass field	0.53	0.09	17
	White wall	0.84	0.21	25
	Beach, on sand	0.71	0.18	25
fully overcast	Grass field	0.17	0.03	18
	White wall	0.17	0.05	29
	Beach, on sand	0.19	0.07	37

[1] Y. K. Chieng and M. A. Green, et al., Computer simulation of enhanced output from bifacial photovoltaic modules, Solar Energy, 137, 19-133, 2016
 [2] X. S. Sun, et al., optimization and performance of bifacial solar modules: A global perspective, Applied Energy, 212, 1601-1610, 2018.

Self-shading models

The shading effect of the wires/cables on the cells depends on:

- the diameter of the wires/cables,
- the length of the cell,
- the distance between the wires/cables and modules.

If the cell length L is 156 mm, d is 10 mm, and h is 100 mm, the K_{wire} would be 3%. Almost no influence

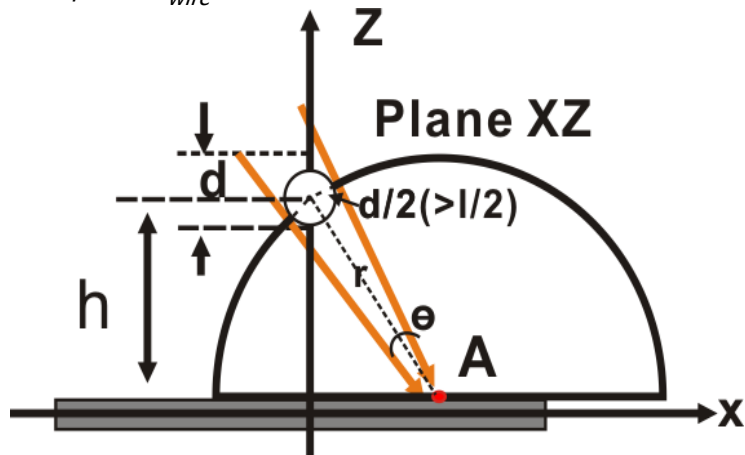

the optical model of the shading effect of cables on point A.

Shading effect on point A:

$$k_{wire} = \frac{\theta}{\pi} \approx \frac{d}{\pi r} = \frac{d}{\pi(x^2 + h^2)^{1/2}}$$

The shading effect (optical loss) K_{wire} on the cell

$$K_{wire} = \int_{-L/2}^{L/2} \frac{k}{L} dx = \int_{-L/2}^{L/2} \frac{d}{\pi(x^2 + h^2)^{1/2} L} dx$$

The solution of the equation

$$K_{wire} = \frac{d}{\pi L} \left(\ln\left(\frac{L}{2} + \sqrt{\left(\frac{L}{2}\right)^2 + h^2}\right) - \ln\left(\sqrt{\left(\frac{L}{2}\right)^2 + h^2} - \frac{L}{2}\right) \right)$$

Self-shading models

- If the holder size is 40 mm, the K_{holder} would be 49.2%.

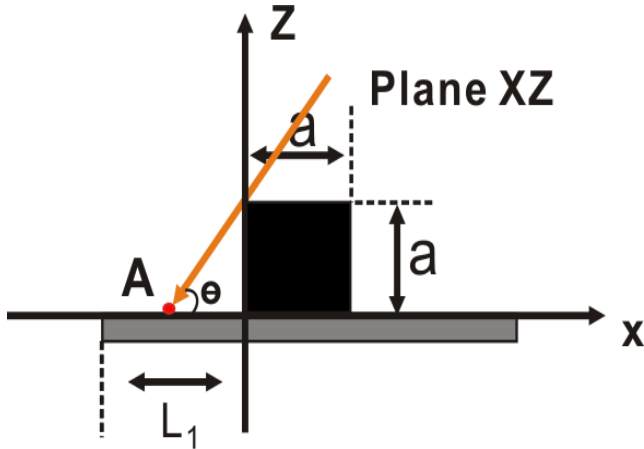

the optical model of the shading effect of holders on point A when the holder is next to the modules.

The shading effect (optical loss) $K_{holderL1}$ on the L_1 part of the cell:

$$\begin{aligned}
 K_{holderL1} &= \int_{-L_1}^0 \frac{\theta}{\pi L_1} dx \\
 &= \int_{\theta_1}^{\pi/2} \frac{2a}{\pi(L-a)} \frac{\theta}{\sin^2 \theta} d\theta \\
 &= \frac{2a}{\pi(L-a)} (\theta_1 \cot \theta_1 - \ln \sin \theta_1) \\
 \tan \theta_1 &= \frac{a}{L/2 - a/2}
 \end{aligned}$$

The shading effect (optical loss) K_{holder} on the cell:

$$K_{holder} = \frac{2 * L_1 * C_2 + a}{L}$$

Self-shading models

- A more general situation

The optical loss changes slower when h is larger than 40 mm

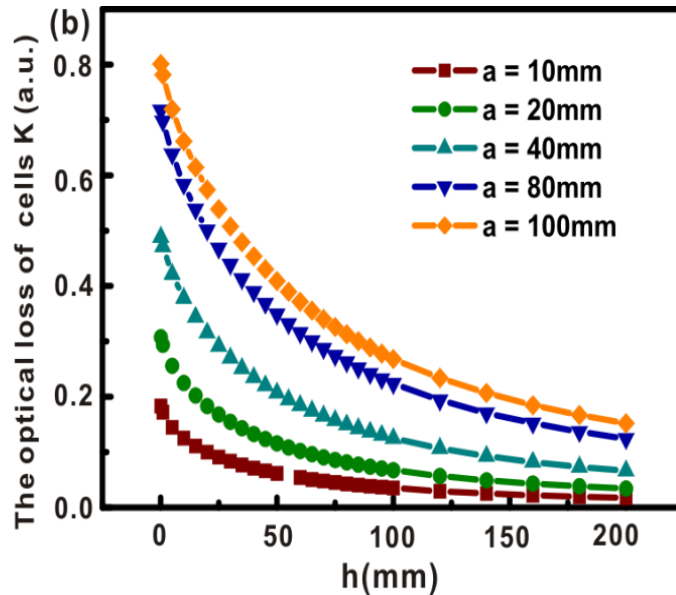
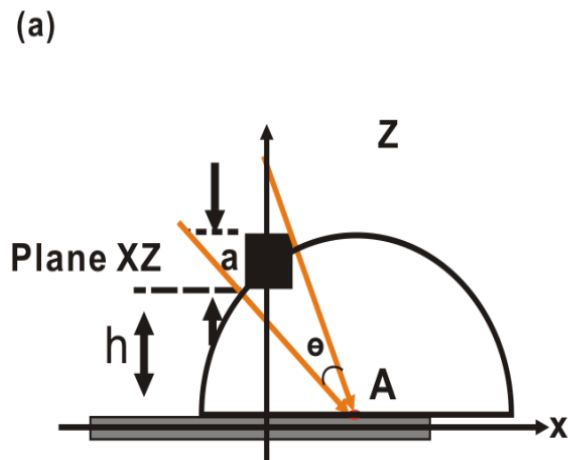

Self-shading models

- Based on the simulation result, increasing the rack clearance or decreasing the rack thickness can help narrow down the optical loss.
- After the field test, the result fits the simulation very well.
- If backside rack shading is unavoidable, set the rack clearance larger than 40mm is highly recommended.



- In some cases, the backside rack shading is unavoidable, as shown by Bo Yu, et al.

Field Test Result and Simulation Result Comparison

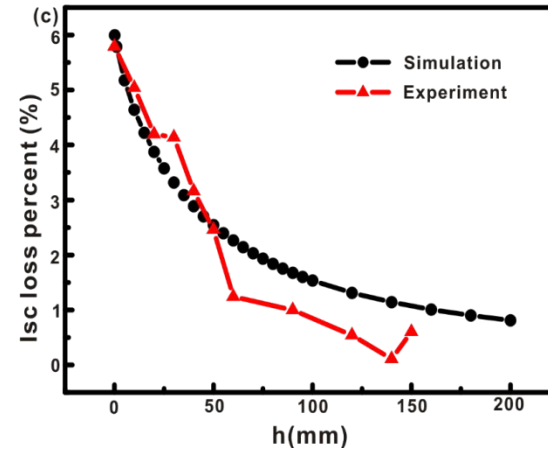

- The influence of rack thickness and clearance is studied in LONGi.

- When eliminating the rack shading, the backside irradiance data from X. S. Sun et al.^[1] still shows that the simulation result is higher than the measured result.
- Maybe we should care about the influence by frames.

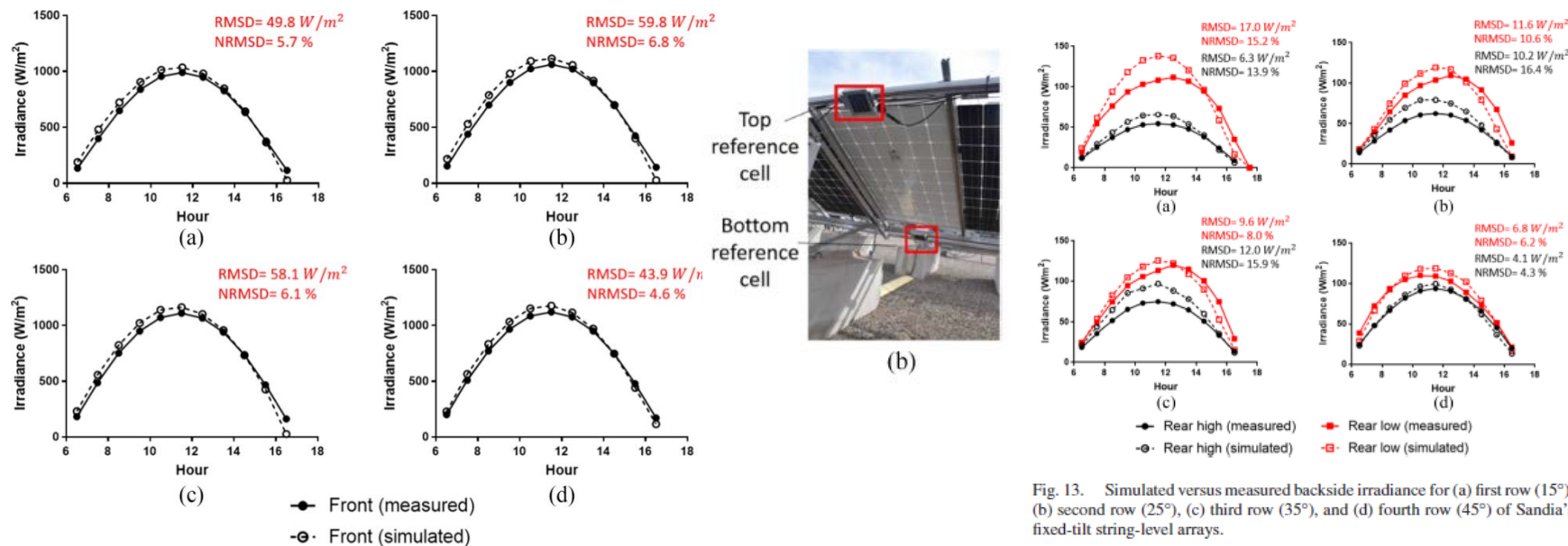
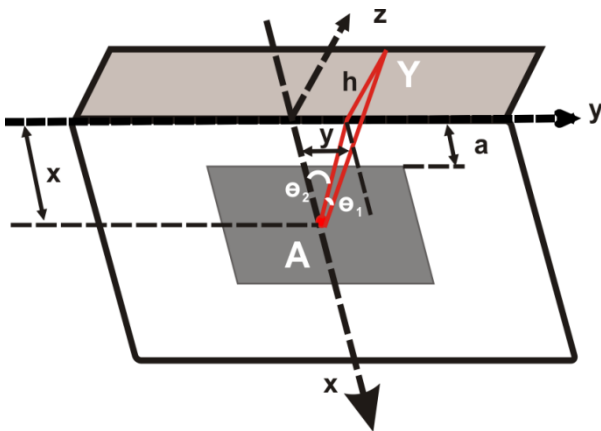

Fig. 13. Simulated versus measured backside irradiance for (a) first row (15°), (b) second row (25°), (c) third row (35°), and (d) fourth row (45°) of Sandia's fixed-tilt string-level arrays.

the shading effect k_{frame} on point A by the frame



$$k_{frame} = \frac{\int_{-\pi/2}^{\pi/2} \arctan\left(\frac{h}{\sqrt{y^2 + x^2}}\right) d\theta_2}{\pi}$$

The shading factor K_{frame} for the whole cell by the frame

$$K = \frac{\int_a^{a+L} \frac{1}{L} \int_{-\pi/2}^{\pi/2} \theta_1 d\theta_2 dx}{\pi}$$

Self-shading models

■ Simulations are made to evaluate the influence factors of frame on shading.

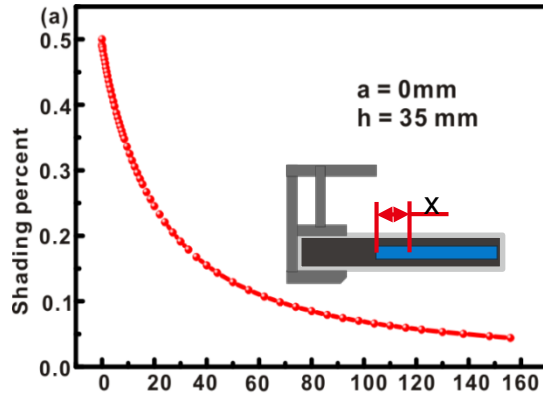

Distance from Cell Edge (mm)

- Shading loss reduces by increasing the distance from cell edge.

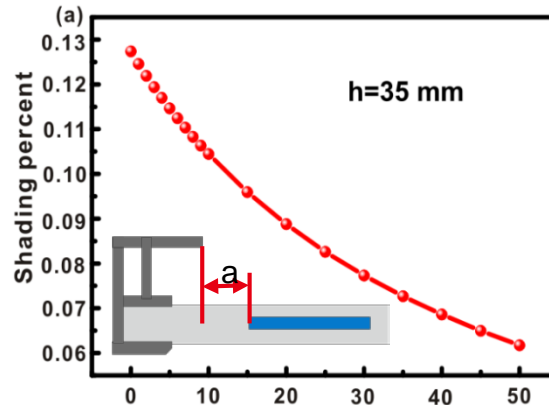

Distance of Cell from Frame (mm)

- Shading loss decreases with the cell & frame distance increasing.

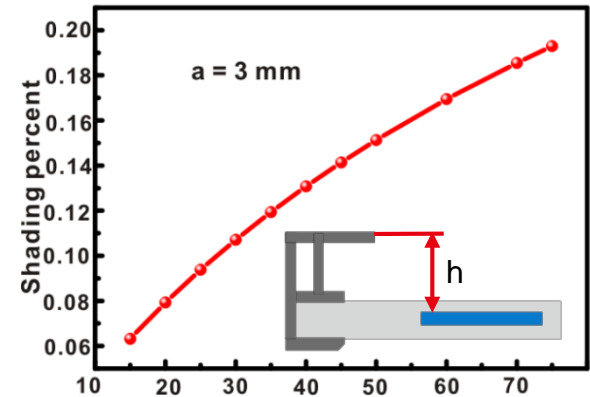

Frame / Supporter Height (mm)

- Shading loss almost have the linear relation with frame/supporter height.

- All the shading from frames will cause illumination loss.
- Even for the bifacial frameless modules , **the supporter and clamp also have the shading effect.**

Self-shading models

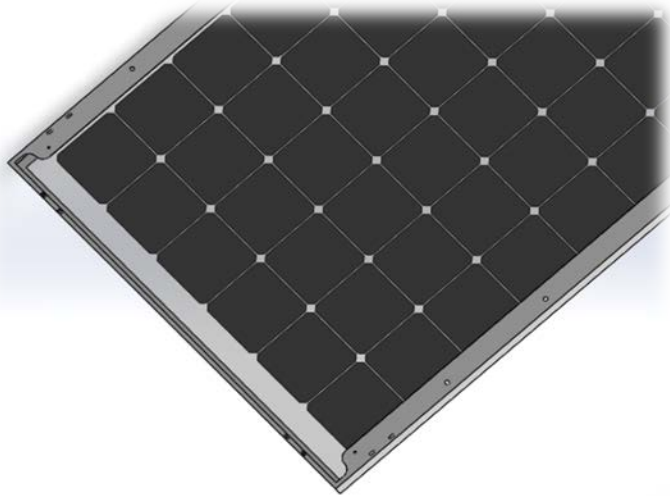

$$\text{Power Gain (Short frame w/o C side)} = \frac{BEG_T \frac{(1 - ETL_N)}{1 - ETL_T} - BEG_T}{1 + BEG_T} = 0.8\%$$

BEG_T : The energy yield gain for traditional designed module
 ETL_N : The backside energy yield loss for new designed frames
 ETL_T : The backside energy yield loss for traditional designed frames

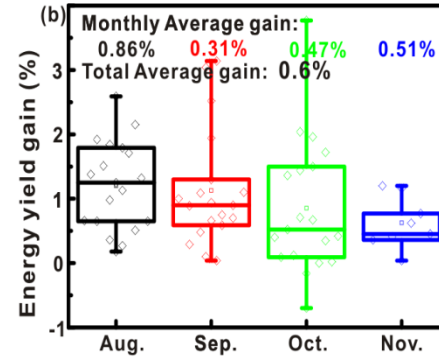
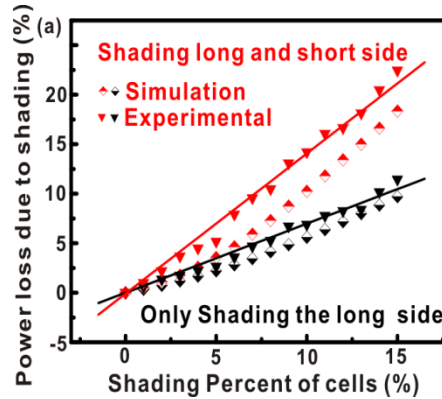

- Take all these frame influence factor into account, LONGi have its perfect frame design to increase the power gain. Both from results of simulation and field test, the power gain of short frame w/o C side is around 0.6%.
- And LONGi highly recommend to install bifacial modules along longer frame to avoid **adding** rack shading.

目录

CONTENTS

- 1 Bifacial products in Longi
- 2 Bifacial energy yield gain in different regions
- 3 Self-shading models
- 4 **Conclusion**



Conclusion

- Bifacial modules could yield more clean energy , the system design should care about installation height, ground reflectance, shading....
- The holder is better to avoid shading, like the system below

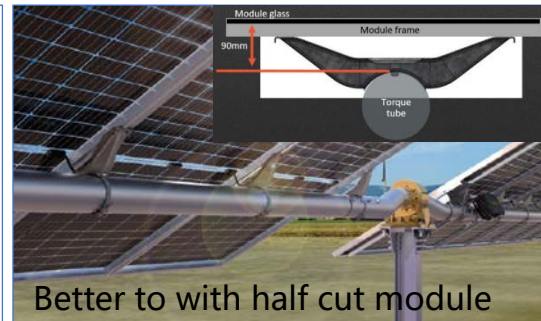
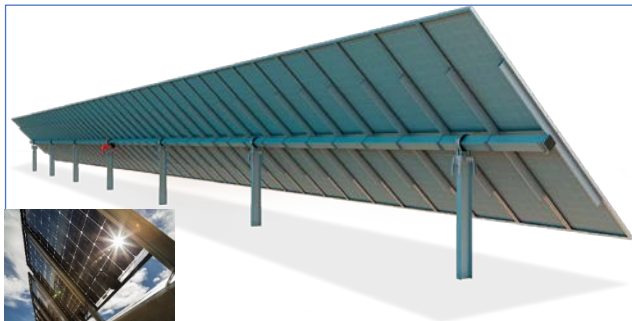
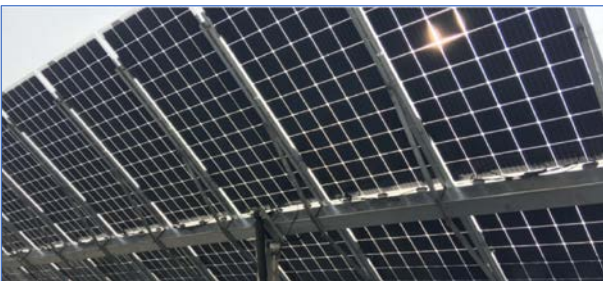

Bifacial : We are working hard for more clean energy!

23.11%
423.98W

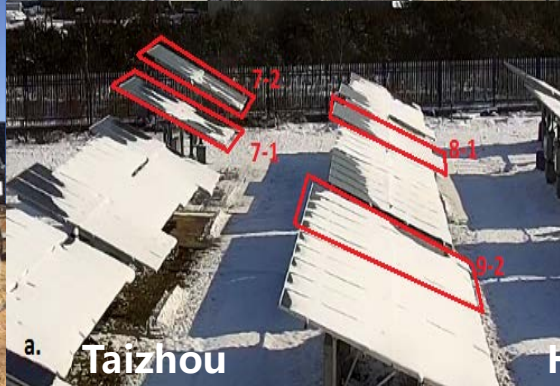

Kubuqi

a. Taizhou

Hainan—Wanning

Turpan



谢谢观看!

THANKS!

The logo for LONGI, featuring the word "LONGI" in white, bold, uppercase letters with a small square above the "i", set against a red square background.

LONGI

地址：陕西省西安市经济开发区尚稷路8989号

电话：029-81566686

传真：029-81566685

ADD:Block B, No.8989 Shangji Road, Xi'an Economic And Technological

Development Zone, Xi'an, Shaanxi, China.

TEL: +86-29-81566686

FAX: +86-29-81566685

www.longigroup.com